

DE Montageanleitung**EN** Mounting instruction**ES** Instrucciones de instalación**FR** Instructions d'installation**IT** Istruzioni per l'installazione**NL** Montagehandleiding**CS** Návod k instalaci**PL** Instrukcja montażu**RU** Инструкция по монтажу

59551 019501	59551 029501
59551 079501	59551 039501
59551 179501	59551 049501
	59551 059501
	59551 129501
	59551 139501

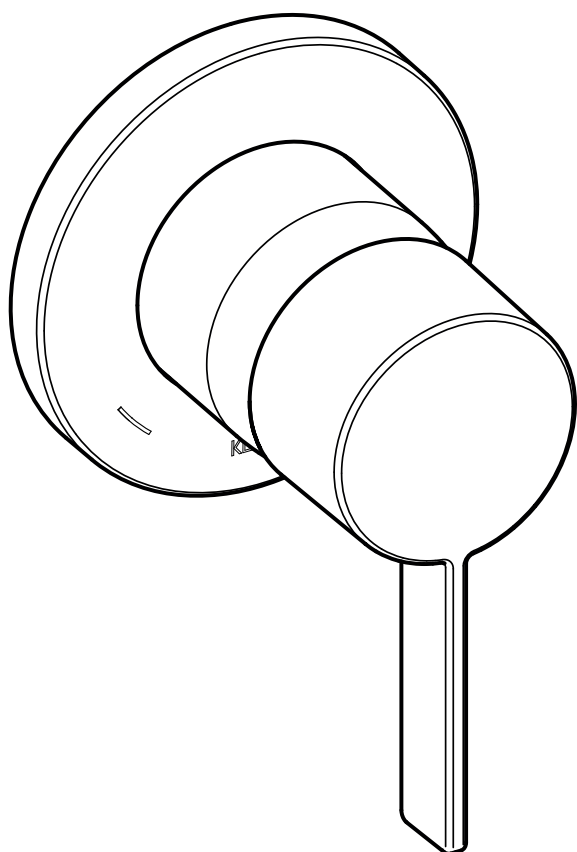
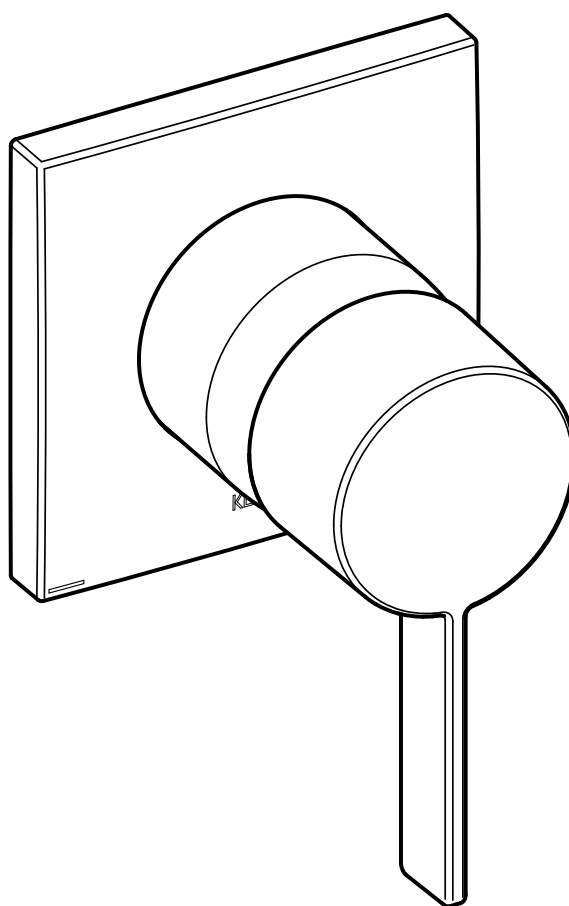

59551 019502	59551 029502
59551 079502	59551 039502
59551 179502	59551 049502
	59551 059502
	59551 129502
	59551 139502

DE Einbaumaße

FR Dimensions de montage

CS Montážní rozměry

EN Mounting dimensions

IT Dimensioni di montaggio

PL Wymiary montażowe

ES Dimensiones de montaje

NL Montageafmetingen

RU Установочные размеры

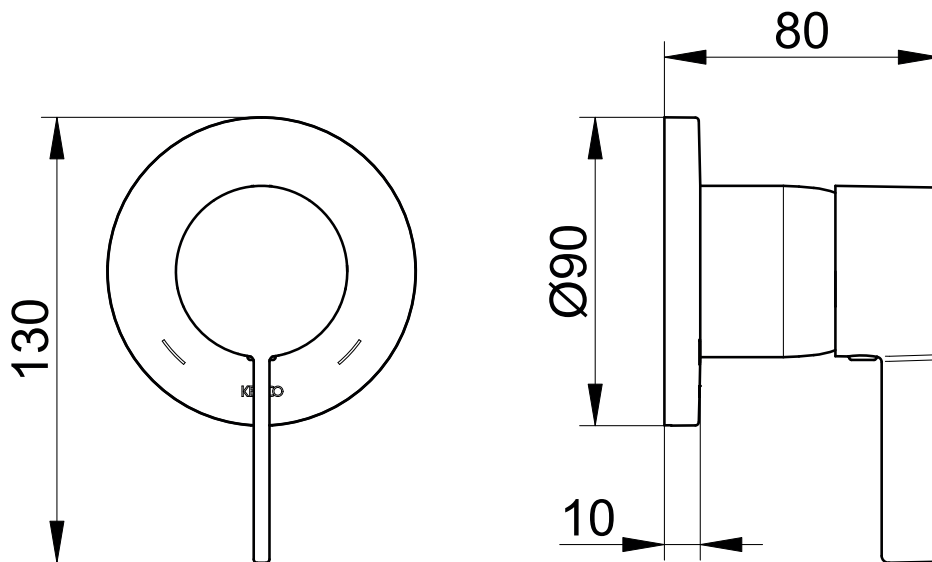

59551 XX9501

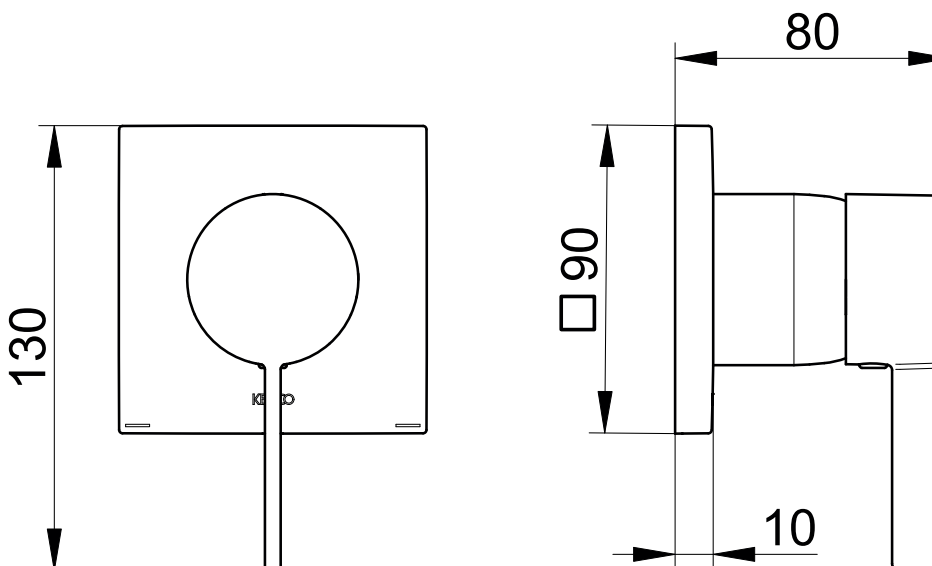











59551 XX9502











 Diese Anleitung ist für den Installateur zur Montage sowie für den Nutzer zur Bedienung und Wartung des Produktes. Bitte nach der Installation an den Nutzer zur Verwahrung weitergeben.

 These instructions are for both the installer for installation and the user for operation and maintenance of the product. After installation, please hand them over to the user to keep.

Symbole und Bedeutung

Symbols and explanations

-  **Achtung!** Warnung vor Personen- oder Sachschaden.
-  Hinweis, Tipp oder Verweis
-  Korrekte Montage/Funktionsprüfung
-  Falsche Montage
-  Montagedetail beachten
-  Kaltwasser  Warmwasser
-  Wasserfluss  Kein Wasserfluss
-  Optional/Zubehör

-  **Attention!** Warning against bodily injury or damage to property.
-  Note, tip or reference
-  Correct installation/test of functionality
-  Incorrect installation
-  Observe installation details
-  Cold water  Hot water
-  Water flow  No water flow
-  Optional/accessories

Verwendungszweck

Intended use

 Einhebelmischer für die Verwendung im Badezimmer.

 Single lever mixer tap for use in bathrooms.

Technische Daten

– Durchfluss bei 3 bar Fließdruck: ca. 23 l/min

Technical specifications

– Flow at 3 bar pressure: approx. 23 l/min

Einbaumaße, siehe Seite 2

Installation dimensions, refer to page 2

Installation, siehe ab Bild 1 auf Seite 8

Installation, refer to picture 1 on page 8

 Nur neutral vernetzendes Silikon verwenden.

 Use only neutrally netting silicone.

Bedienung, siehe Bild 8 auf Seite 9

Operation, refer to picture 8 on page 9

Temperatur- und Durchflussbegrenzung, siehe Bild 9 bis 11 auf Seite 9

Montage in umgekehrter Reihenfolge.

Temperature controll and flow rate limiter, refer to picture 9 to 11 on page 9

Assemble in reverse order.

Wartung, siehe Bild 12 auf Seite 9

Montage in umgekehrter Reihenfolge.

– Anzugsmoment Kartuschenmutter: 12-13 Nm

Servicing, refer to picture 12 on page 9

Assemble in reverse order.

– Cartridge nut torque: 12-13 Nm

Ersatzteile mit Bestellnummern, siehe Seite 11











For spare parts with order numbers, refer to page 11

 Hinweise zur Gewährleistung und Pflege sind dem beiliegendem **Pflege- und Garantiepäss** zu entnehmen.

 For warranty and care information please refer to the attached **warranty and care instructions**.

 Este manual está dirigido al instalador para el montaje, así como al usuario para el manejo y mantenimiento del producto. Por favor, después de la instalación, este manual se debe entregar al usuario para que lo conserve.

Símbolos y significado

-  ¡Atención! Advertencia de daños personales o materiales.
-  Indicación, consejo o referencia
-  Montaje/comprobación de funcionamiento correctos
-  Montaje erróneo
-  Observar el detalle de montaje
-  Agua fría
-  Agua caliente
-  Flujo de agua
-  Ningún flujo de agua
-  Opcional/Accesorios

Uso previsto

 Mezclador monomando para la utilización en el baño.

Datos técnicos

– Paso con una presión de caudal de 3 bares:
aprox. 23 l/min.

Medidas de montaje, véase página 2

Instalación, véase imagen 1 en la página 8

 Utilizar exclusivamente silicona de reticulación neutra.

Manejo, véase imagen 8 en la página 9

Limitador de temperaturay y limitación de caudal, véase imágenes 9 a 11 en la página 9

El montaje se efectúa en el orden inverso.

Mantenimiento, véase imagen 12 en la página 9









El montaje se efectúa en el orden inverso.
– Par de apriete de la tuerca de fijación del cartucho: 12-13 Nm

Piezas de recambio con números de pedido, véase página 11

 En el pasaporte de mantenimiento y garantía adjunto encontrará indicaciones sobre la **garantía y el mantenimiento.**

 Ces instructions sont destinées à l'installateur, pour effectuer le montage, et pour l'utilisateur, pour utiliser le produit et procéder à sa maintenance. Après l'installation, veuillez remettre ces instructions à l'utilisateur pour qu'il les conserve.

Symboles et leur signification

-  **Attention !** Mise en garde contre les dégâts de personnes et les dégâts matériels.
-  Remarque, conseil ou renvoi
-  Montage correct/contrôle fonctionnel
-  Montage incorrect
-  Respecter le détail de montage
-  Eau froide
-  Eau chaude
-  Débit d'eau
-  Pas de débit d'eau
-  Option/accessoires

Domaine d'utilisation

 Mitigeur monocommande pour utilisation dans la salle de bains.

Caractéristiques techniques

– Débit à une pression d'écoulement de 3 bar :
env. 23 l/mn

Cotes d'encombrement, voir page 2

Installation, voir figure 1 à la page 8

 N'utiliser que du silicone à réticulation neutre.

Utilisation, voir figure 8 à la page 9

Limiteur de température et limiteur de débit, voir figures 9 à 11, page 9

Le montage s'effectue dans l'ordre inverse de la dépose.

Maintenance, voir figure 12, page 9

Le montage s'effectue dans l'ordre inverse de la dépose.
– Couple de serrage écrou de cartouche :
12-13 Nm

Pièces de rechange avec numéros de commande, voir page 11

 Les consignes relatives à la garantie et à l'entretien figurent sur la carte **d'entretien et de garantie** jointe.

 Il presente manuale è indirizzato agli installatori per il montaggio nonché agli utilizzatori per l'uso e la manutenzione del prodotto. Consegnarlo all'utilizzatore dopo l'installazione affinché lo custodisca.

Simboli e significato

 **Attenzione!** Pericolo di lesioni o danni materiali.

 Avvertenza, consiglio o rimando

 Montaggio corretto/verifica del funzionamento

 Montaggio errato

 Prestare attenzione al dettaglio di montaggio

 Acqua fredda  Acqua calda

 Flusso d'acqua  Nessun flusso d'acqua

 Opzionale/accessorio

Scopo d'uso

 Miscelatore monocomando per l'utilizzo in bagno.

Dati tecnici

– Portata con pressione di flusso di 3 bar:
circa 23 l/min

Ingombro, vedi pagina 2

Installazione, vedi dalla figura 1 a pagina 8

Utilizzare solo silicone neutro.



Uso, vedi figura 8 a pagina 9

Dischi di tenuta in ceramica limitatore di temperatura e limitazione di portata, vedi figura 9 - 11 a pagina 9
Eseguire il montaggio in ordine inverso.

Manutenzione, vedi figura 12 a pagina 9

Eseguire il montaggio in ordine inverso.

– Coppia del dado della cartuccia: 12-13 Nm

Ricambi con numero d'ordine, vedi pagina 11

 Indicazioni relative alla garanzia e al trattamento vanno desunte dalla **scheda allegata**.

 Deze handleiding is bestemd voor zowel de installateur voor de montage alsook voor de gebruiker voor het gebruik en het onderhoud van het product. Gelieve na de installatie door te geven aan de gebruiker om te bewaren.

Symbolen en betekenis

 **Opgepast!** Gevaar voor letsel of schade.

 Opmerking, tip of referentie

 Correcte montage/werkingstest

 Verkeerde montage

 Montagedetails in acht nemen

 Koud water  Heet water

 Waterstroom  Geen waterstroom

 Optioneel/toebehoren

Bestemd gebruik

 Eenhendelmengkraan voor gebruik in badkamer.

Technische gegevens

– Doorstroming bij 3 bar stromingsdruk:
ca. 23 l/min

Inbouwafmetingen, zie pagina 2

Installatie, zie vanaf afbeelding 1 op pagina 8

Uitsluitend neutraal vernette siliconen gebruiken.



Gebruik, zie afbeelding 8 op pagina 9

Temperatuurbegrenzer en begrensd waterdoorlaat, zie afbeelding 9 - 11 op pagina 9

Montage in omgekeerde volgorde.

Onderhoud, zie afbeelding 12 op pagina 9

Montage in omgekeerde volgorde.

– Aandraaimoment moer voor cartouche:











12-13 Nm

Wisselstukken met bestelnummers, zie pagina 11

 Instructies voor de waarborg en het onderhoud vindt u in de meegeleverde **Onderhouds- en garantiokaart**.

 Tento návod slouží instalatérům při montáži a uživatelům při obsluze a údržbě produktu. Po nainstalování ho předejte uživateli, aby si ho mohl uschovat.

Symbole a význam

-  **Pozor!** Výstraha před zraněním a věcnými škodami.
-  Upozornění, tip nebo odkaz
-  Správná montáž / kontrola funkčnosti
-  Nesprávná montáž
-  Při montáži dbejte na tento detail
-  Studená voda  Teplá voda
-  Průtok vody  Žádný průtok vody
-  Volitelná výbava / příslušenství

Účel použití

 Páková směšovací armatura pro použití v koupelnách.

Technické údaje

– Průtok při průtokovém tlaku 3 bary: cca. 23 l/min

Montážní rozměry viz strana 2

Instalace viz obrázek 1 na straně 8

 Používejte pouze neutrální silikon.

Obsluha viz obrázek 8 na straně 9

Teplotní zarážkou a průtok omezen viz snímky 9 - 11 na straně 9

Montáž probíhá v obráceném pořadí.

Údržba viz obrázek 12 na straně 9









Montáž probíhá v obráceném pořadí.
– Uťahovací moment matice kartuše: 12-13 Nm

Náhradní díly s objednáacími čísly viz strany 11

 Pokyny týkající se záruky a péče najdete v příloženém **Návodu k údržbě a záručním listu**.

 Instrukcja przeznaczona jest dla instalatora, zapewniając pomoc w zakresie montażu oraz dla użytkownika, informując go o sposobie obsługi i konserwacji produktu. Po instalacji należy przekazać instrukcję użytkownikowi, aby ją u siebie przechowywał.

Symbole i znaczenie

-  **Uwaga!** Ostrzeżenie przed szkodami osobowymi i materialnymi.
-  Informacja, dobra rada lub odsyłacz
-  Właściwy montaż / kontrola funkcjonowania
-  Niewłaściwy montaż
-  Należy stosować się do danych, dotyczących montażu
-  Woda zimna  Woda gorąca
-  Strumień wody  Brak strumienia wody
-  Opcje / Osprzęt

Przeznaczenie

 Bateria jednouchwytna do stosowania w łazience.

Dane techniczne

– Przepływ w przypadku ciśnienia hydraulicznego 3 bar: około 23 l/min

Wymiary zabudowy, patrz strona 2

Instalacja, patrz rys. 1 na stronie 8

 Należy wykorzystywać wyłącznie silikon, ulegający naturalnemu usieciowaniu.

Obsługa, patrz rys. 8 na stronie 9

Kontroli temperatury i ograniczenie przepływu, patrz rys. 9 do 11 na stronie 9

Montaż w odwrotnej kolejności.

Konserwacja, patrz rys. 12 na stronie 9

Montaż w odwrotnej kolejności.
– Moment obrotowy dokręcenia nakrętki głowicy: 12-13 Nm

Części zamienne z numerami zamówienia, patrz strona 11

 Informacje dotyczące gwarancji dostępne są w dołączonej **karcie pielęgnacyjno-gwarancyjnej**.

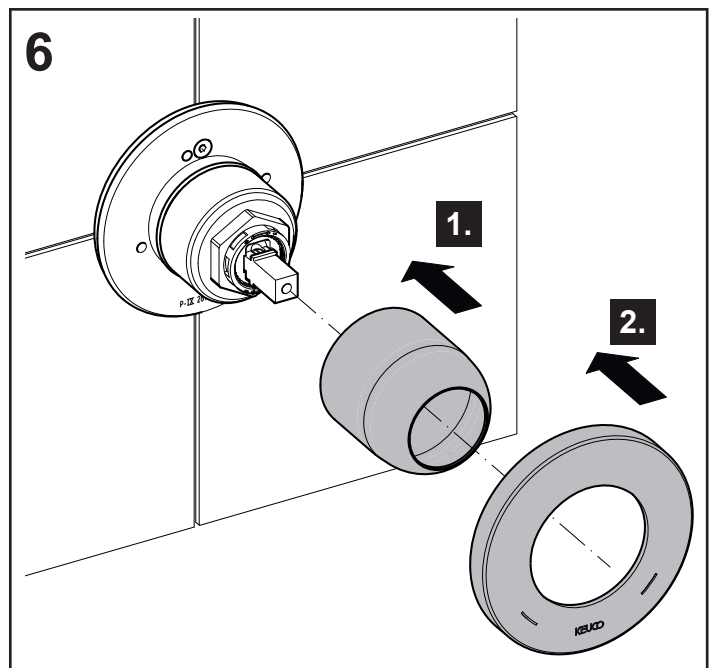
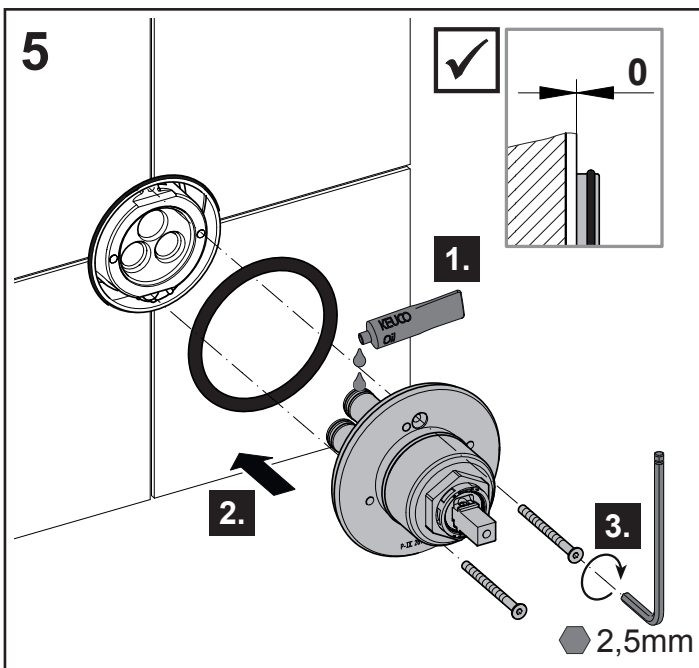
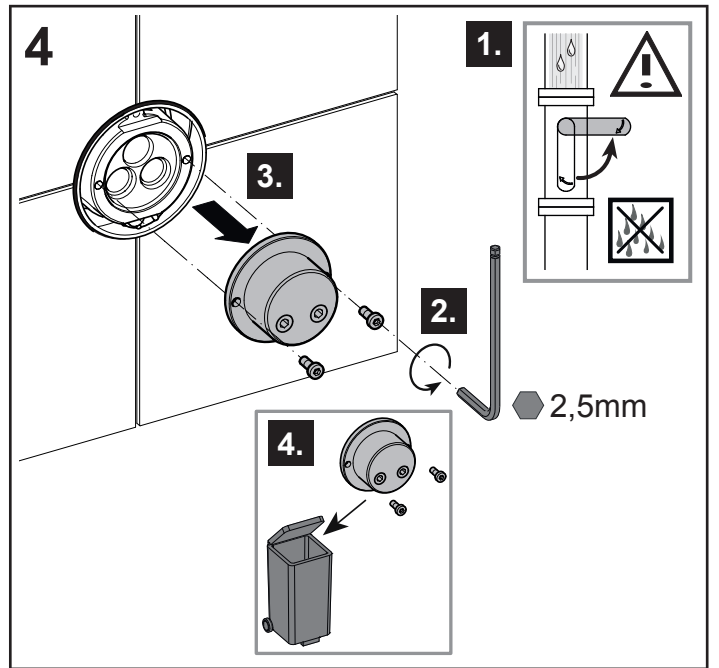
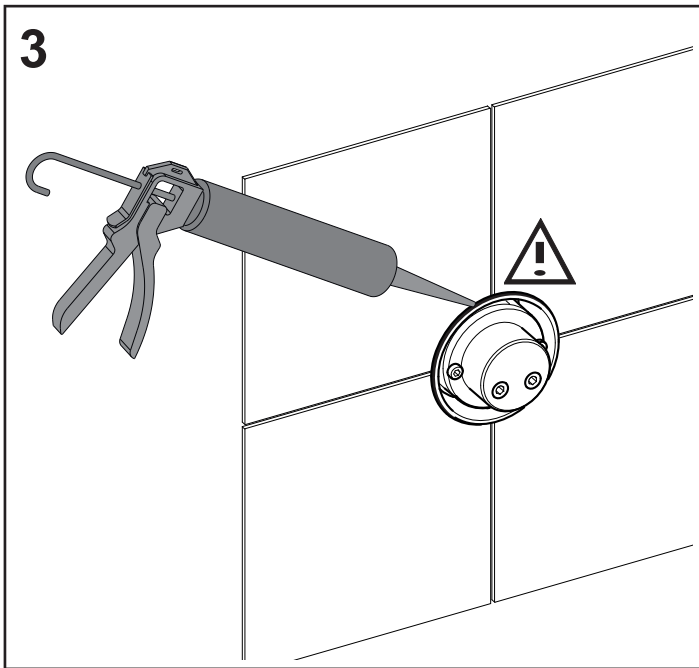
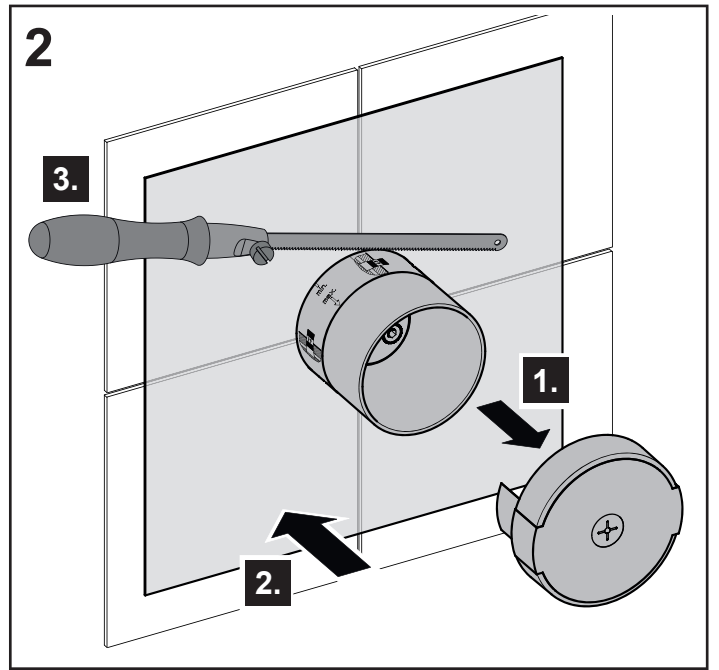
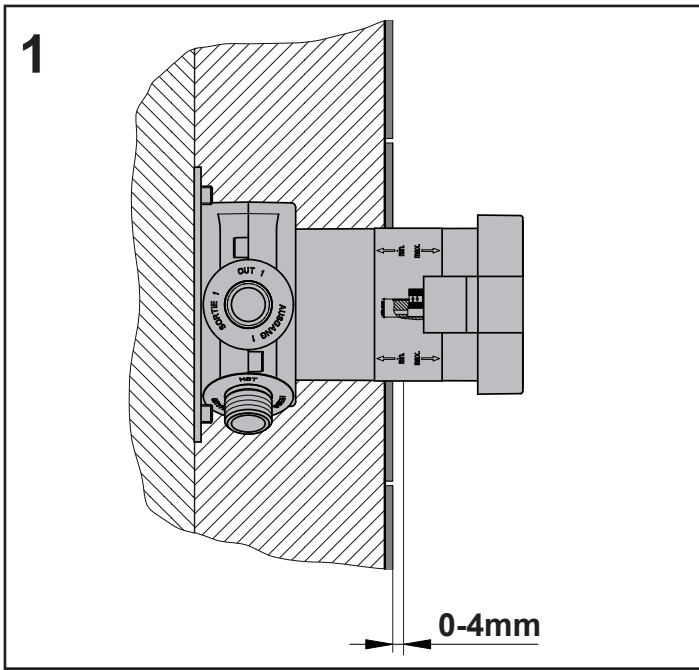

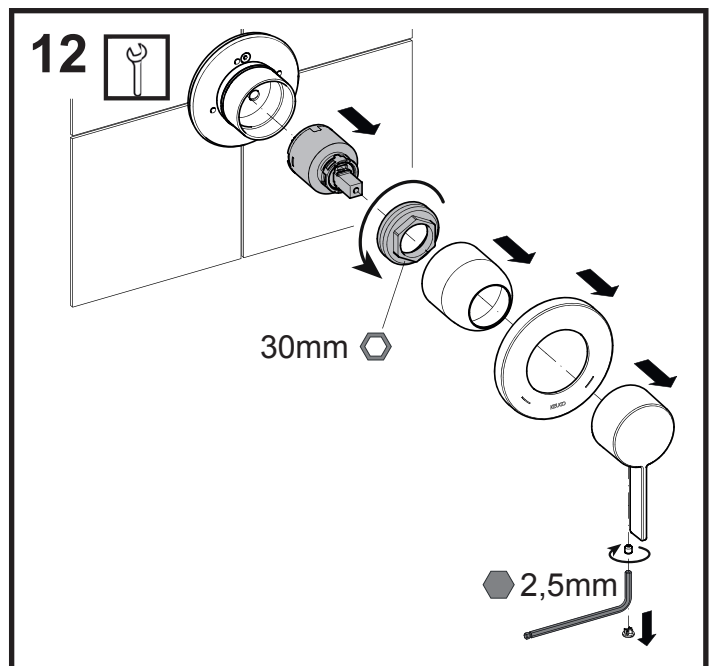
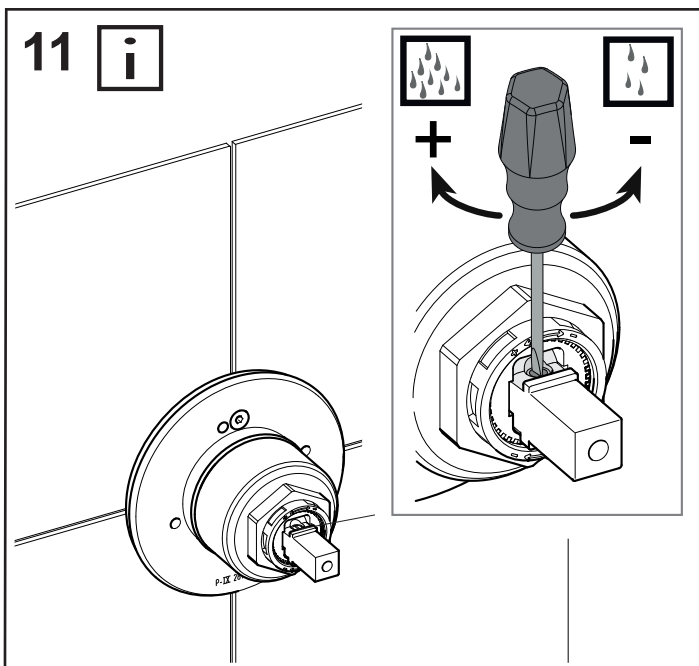
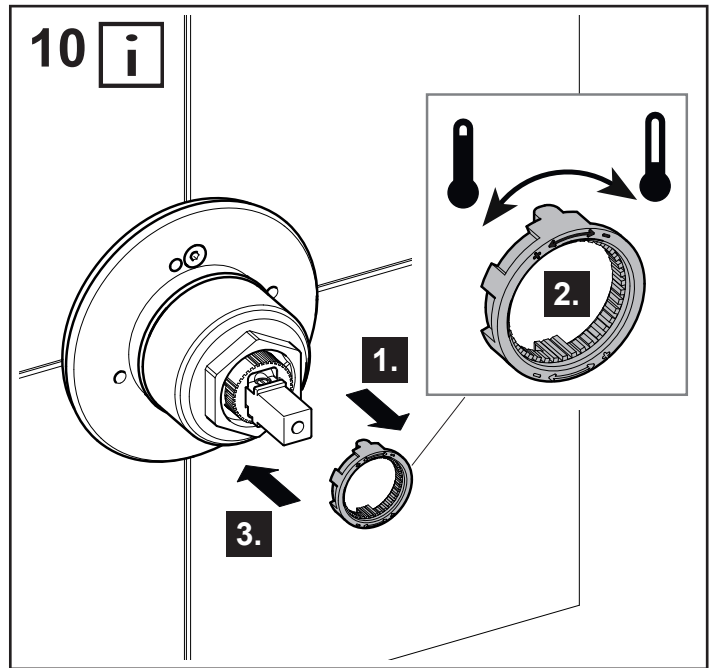
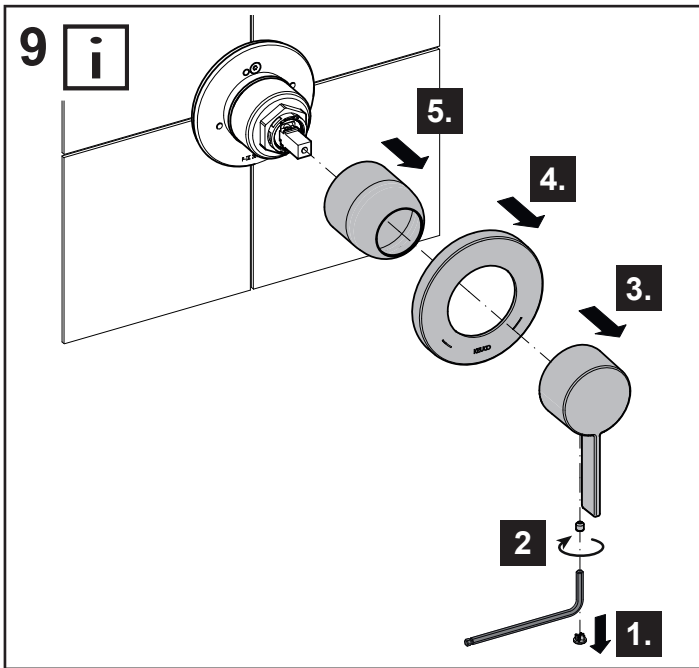
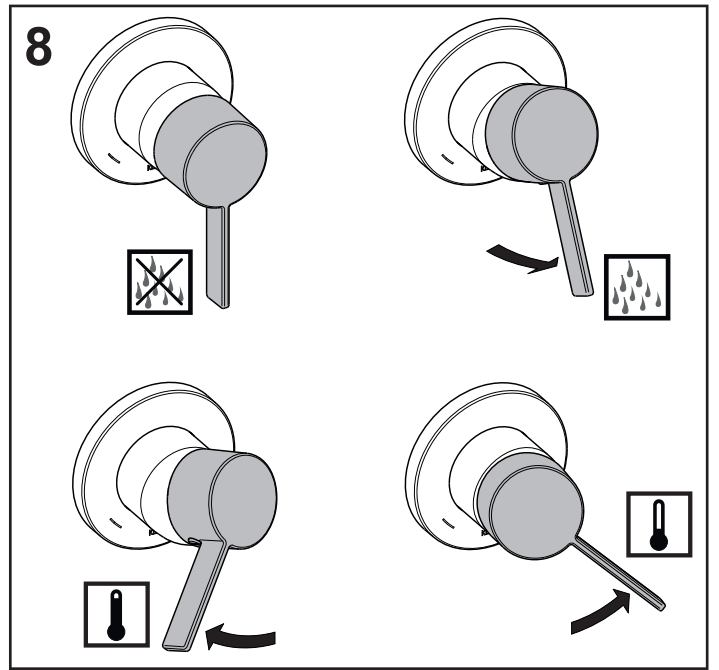
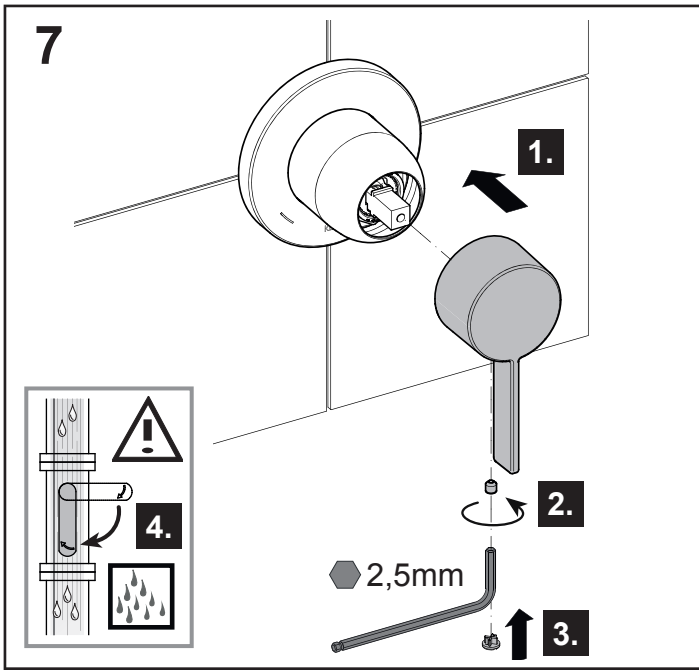



A series of 20 horizontal lines for writing, spaced evenly down the page.

DE Ersatzteile

FR Liste de pièces

CS Náhradní díly

EN Spare parts

IT Elenco delle parti

PL Zestaw części

ES Piezas de recambio

NL Onderdelen

RU Запчасти

59551 XX9501 59551 XX9502

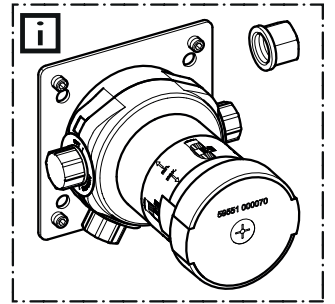
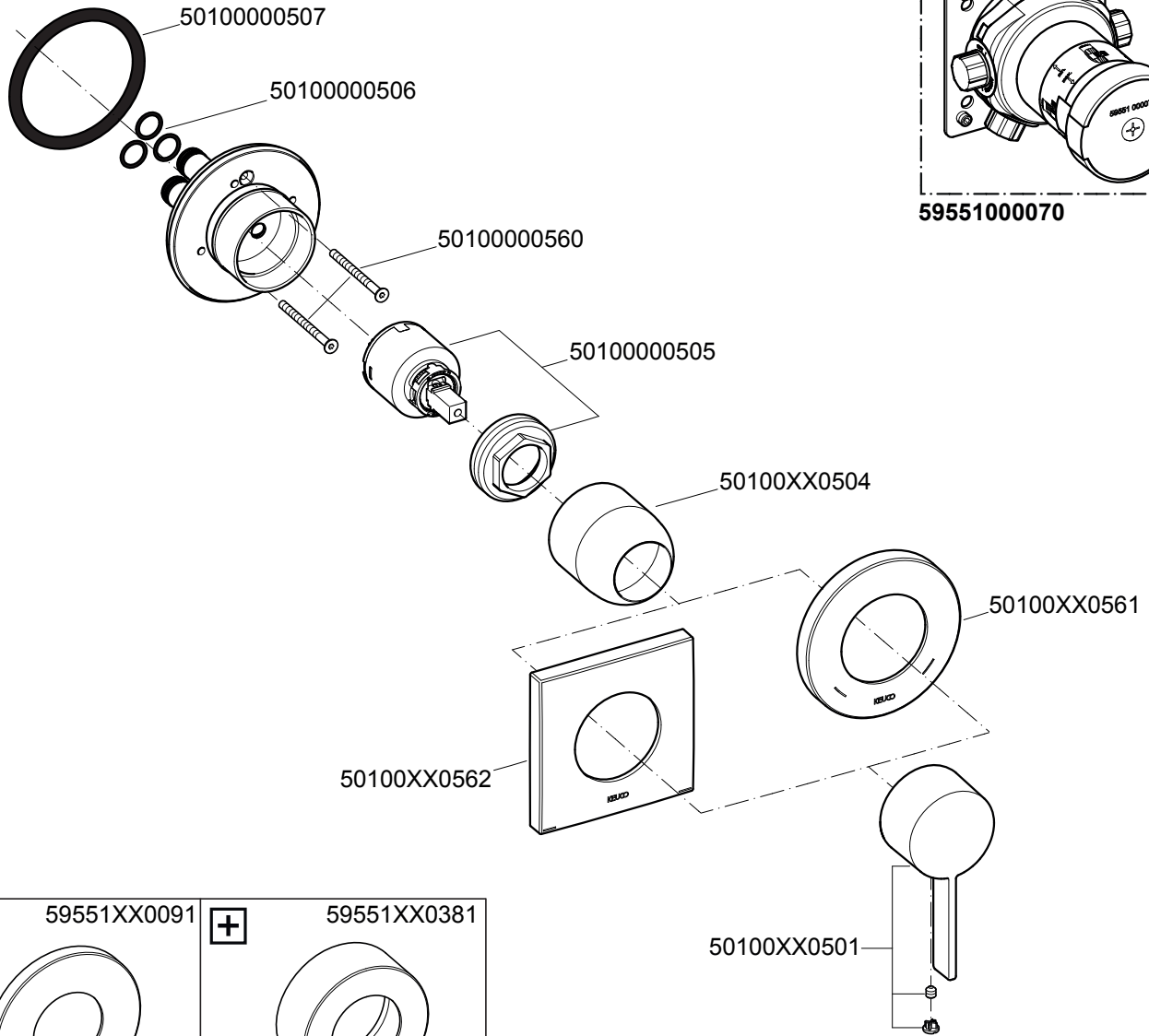

59551000070

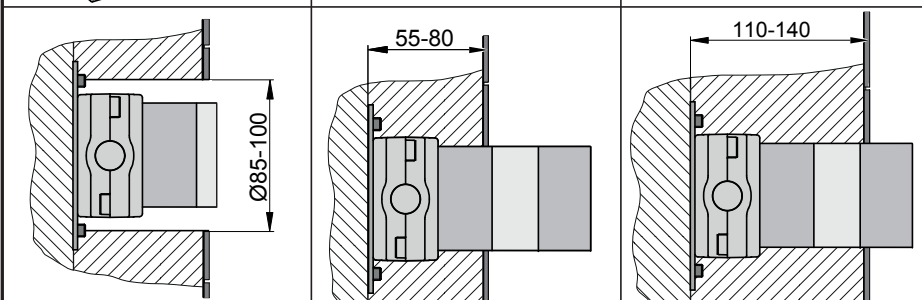
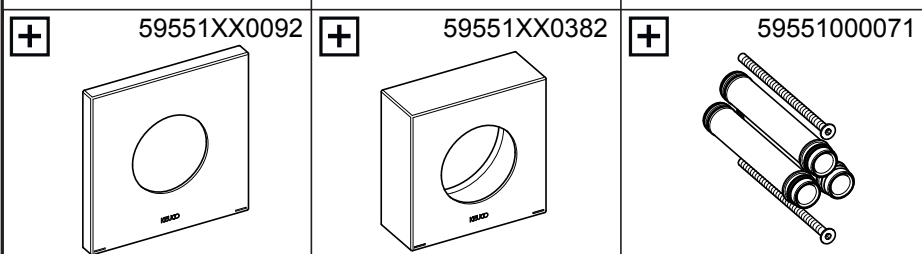
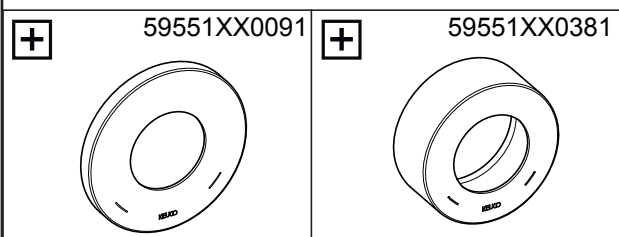

XX = 01, 07, 17, 02, 03, 04, 05, 12, 13

DE

KEUCO GmbH Co. KG
Oesestraße 36
D-58675 Hemer
Telefon: +49 2372 904-0
E-Mail: info@keuco.de

AT

KEUCO GmbH
Söllheimerstraße 16
Objekt 6c
A-5020 Salzburg
Telefon: +43 662 4540560
E-Mail: office@keuco.at

CH

KEUCO AG
Winkelweg 3
CH-5702 Niederlenz
Telefon: +41 62 8880020
E-Mail: info@keuco.ch

EN

KEUCO UK Ltd
Amersham House
Mill Street
GB-Berkhamsted HP4 2DT
Phone: +44 10442865220
E-Mail: admin@keuco.co.uk

FR

KEUCO SARL
5, Rue du Martelberg
F-67700 Monswiller
Téléphone: +33 3 88700200
E-Mail: bureau@keuco.fr

NL

KEUCO GmbH Co. KG
Kantoor Nederland
Postbus 1286
5004 BG Tilburg
Telefoon: +31 88 6 333 999
E-Mail: info@keuco.nl

RU

KEUCO GmbH Co. KG
Представительство в России
Космодамианская набережная,
дом 4 / 22, корпус Б
115035 Москва
Электронная почта:
mikhail.komendantov@keuco.com

US

KEUCO Management Inc.
3675 Crestwood Parkway NW,
Suite 222
Duluth, GA 30096
Phone: +1 877 281 8260
E-Mail: office-usa@keuco.com

