

Edition 11

31253180100 Waschtischunterbau

**PRODUKT**

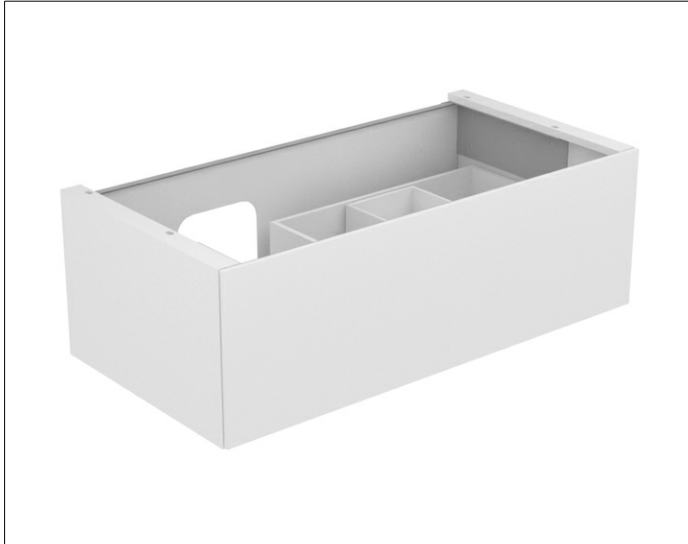

**ZEICHNUNG**

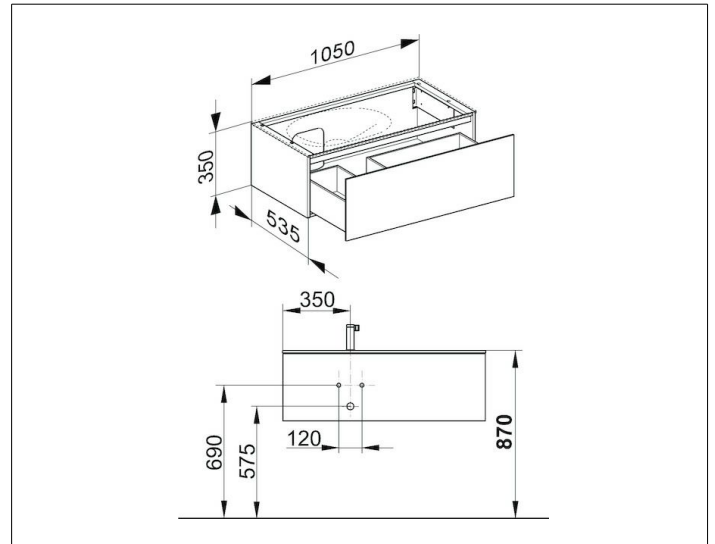

EEK: F ,

**OBERFLÄCHE**

cashmere/Glas cashmere

**ABMESSUNG**

1050 x 350 x 535 mm