

Edition 400

31759380000 Sockelpaket

**PRODUKT**



**ZEICHNUNG**

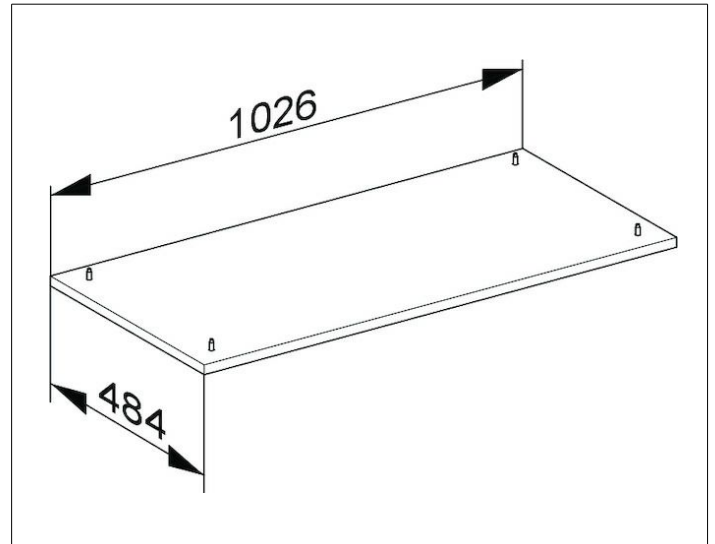

**OBERFLÄCHE**

weiß/weiß

**ABMESSUNG**

1026 x 25 x 484 mm