

Edition 11

31268570000 Waschtischunterbau

**PRODUKT**



**ZEICHNUNG**

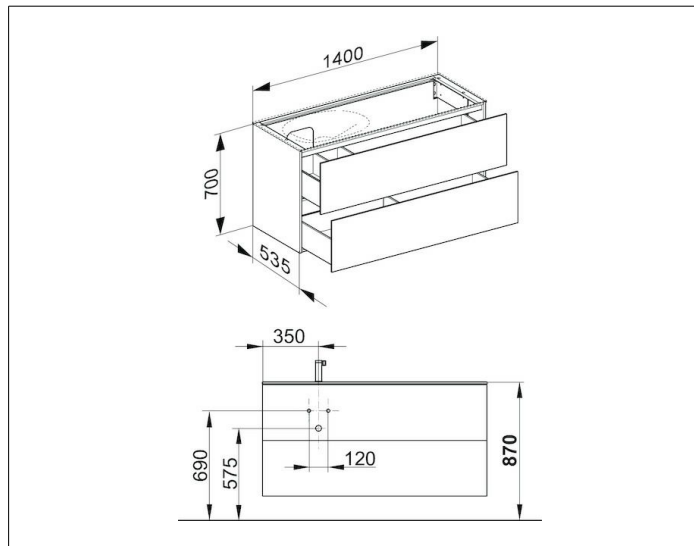

**OBERFLÄCHE**

schwarz/Glas schwarz

**ABMESSUNG**

1400 x 700 x 535 mm