

Edition 11

31253380100 Waschtischunterbau

PRODUKT

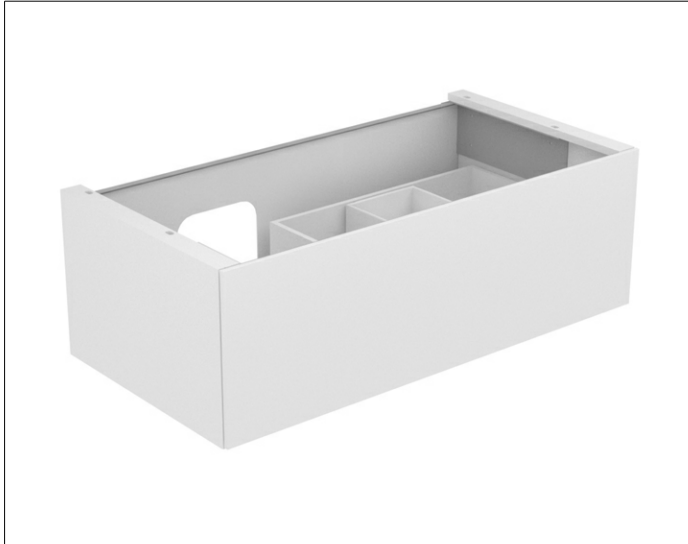

ZEICHNUNG

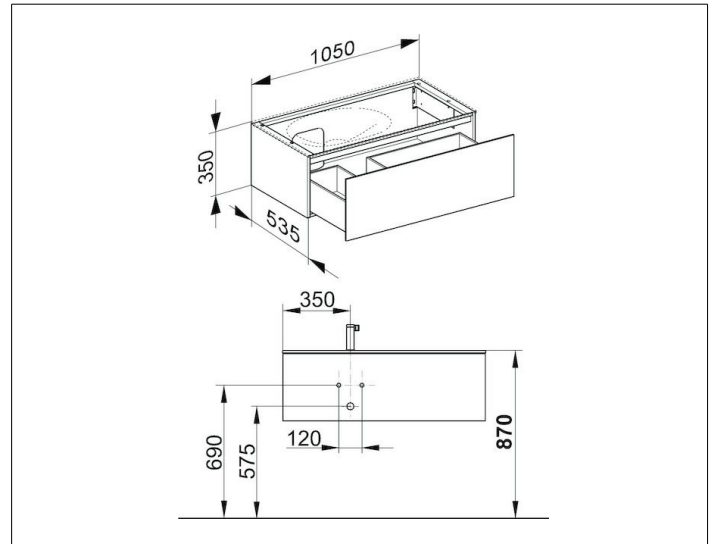

EEK: F , 7 kWh/1000h

OBERFLÄCHE

weiß/weiß

ABMESSUNG

1050 x 350 x 535 mm