

Edition 11

31241390100 Waschtischunterbau

PRODUKT

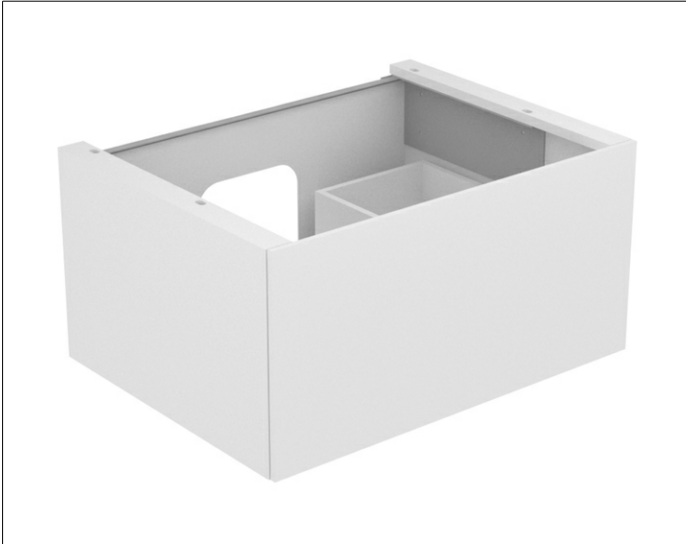

ZEICHNUNG

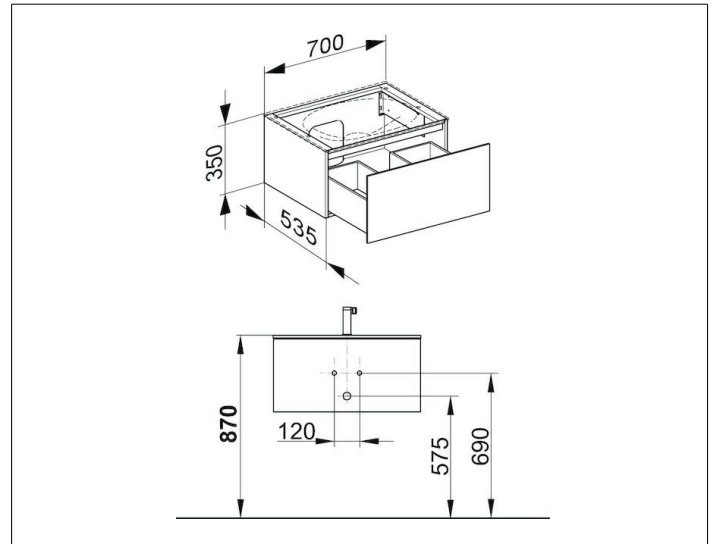

EEK: F , 5 kWh/1000h

OBERFLÄCHE

anthrazit/anthrazit

ABMESSUNG

700 x 350 x 535 mm