

Edition 11

31312280100 Modul Unterbauschrank

**PRODUKT**



**ZEICHNUNG**

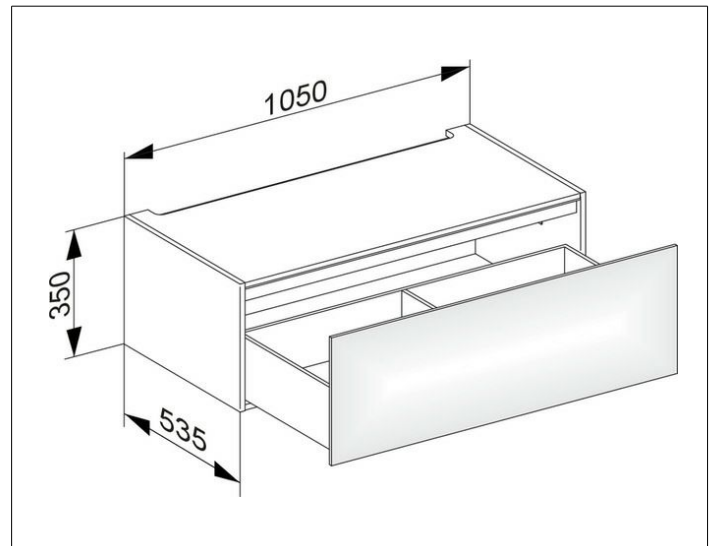

EEK: F ,

**OBERFLÄCHE**

cashmere/Glas cashmere satiniert

**ABMESSUNG**

1050 x 350 x 535 mm