

Edition 400

31573870000 Waschtischunterbau

PRODUKT



ZEICHNUNG

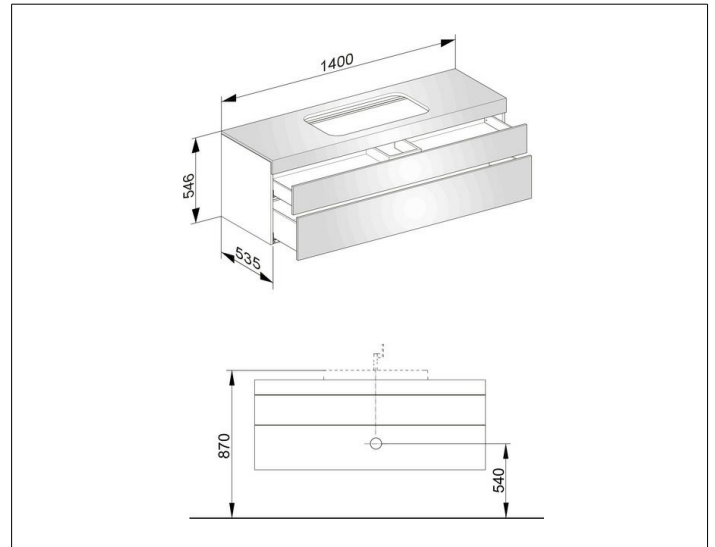

OBERFLÄCHE

Eiche cashmere/Eiche cashmere

ABMESSUNG

1400 x 546 x 535 mm