

Edition 11

3126130000 Waschtischunterbau

PRODUKT

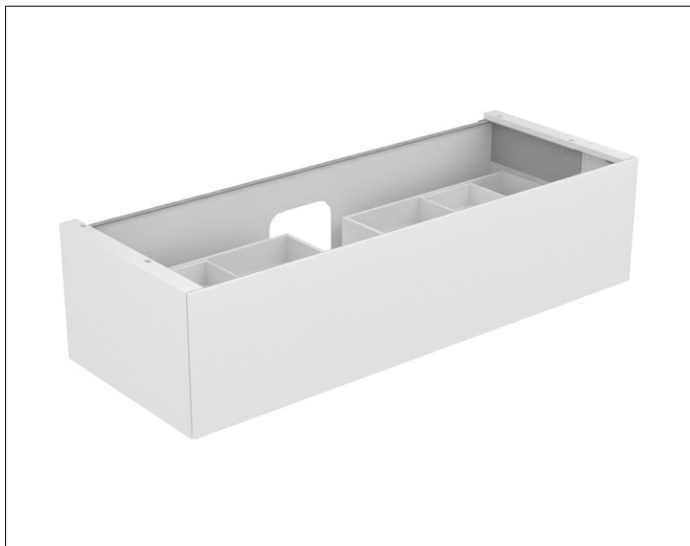

ZEICHNUNG

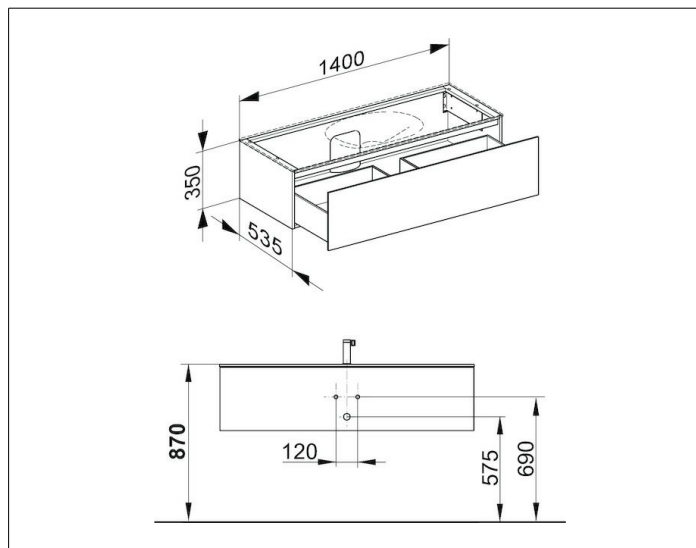

OBERFLÄCHE

weiß/Glas weiß

ABMESSUNG

1400 x 350 x 535 mm