

Edition 400

31574180000 Waschtischunterbau

PRODUKT



ZEICHNUNG

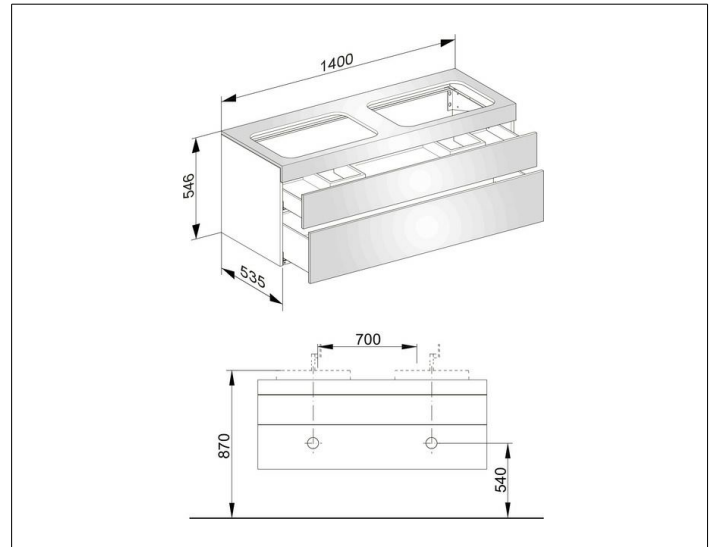

OBERFLÄCHE

cashmere/Glas cashmere klar

ABMESSUNG

1400 x 546 x 535 mm