

Edition 11

31310140100 Modul Unterbauschrank

PRODUKT

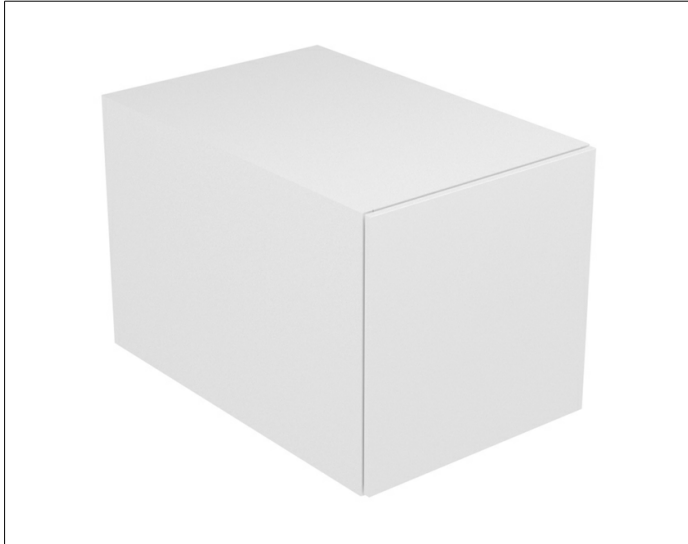

ZEICHNUNG

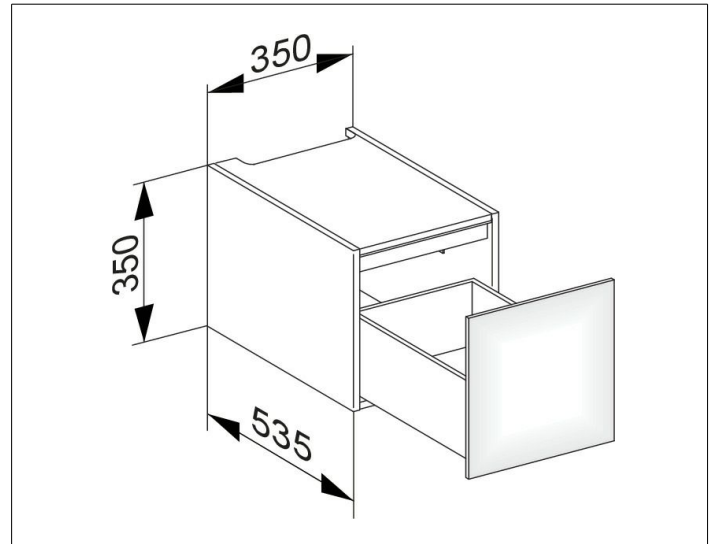

EEK: F , 2 kWh/1000h

OBERFLÄCHE

trüffel/Glas trüffel

ABMESSUNG

350 x 350 x 535 mm