

X-Line

33122110002 Waschtischunterbau

PRODUKT

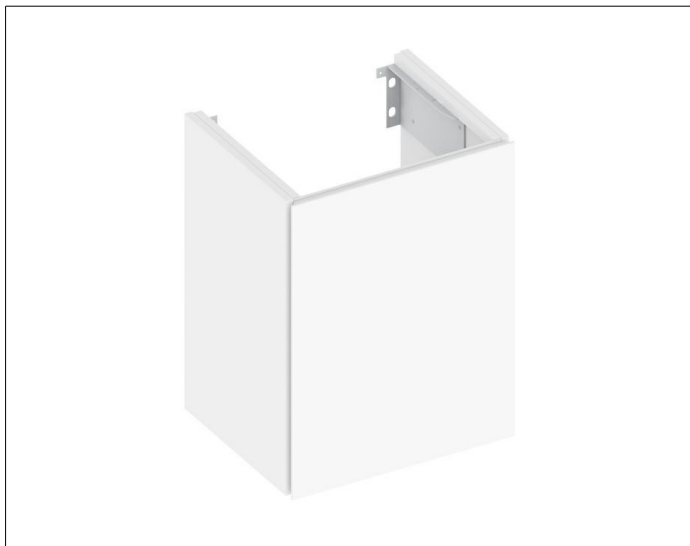

ZEICHNUNG

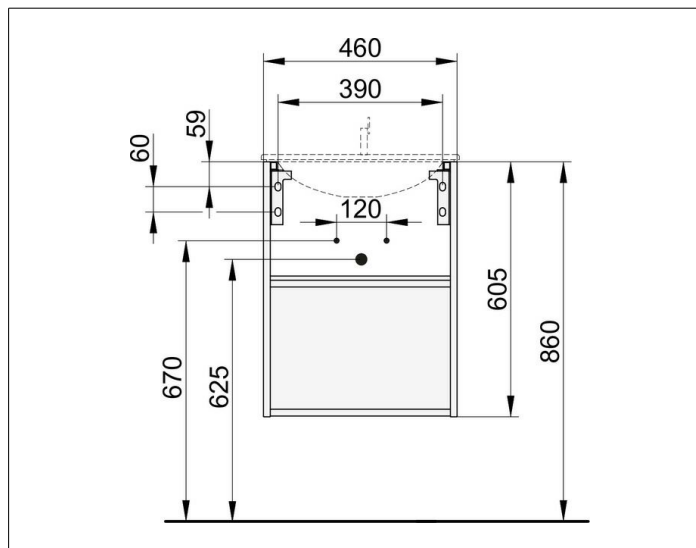

OBERFLÄCHE

anthrazit/anthrazit

ABMESSUNG

460 x 605 x 380 mm