

Edition 400

31779870000 Sockelpaket

**PRODUKT**



**ZEICHNUNG**

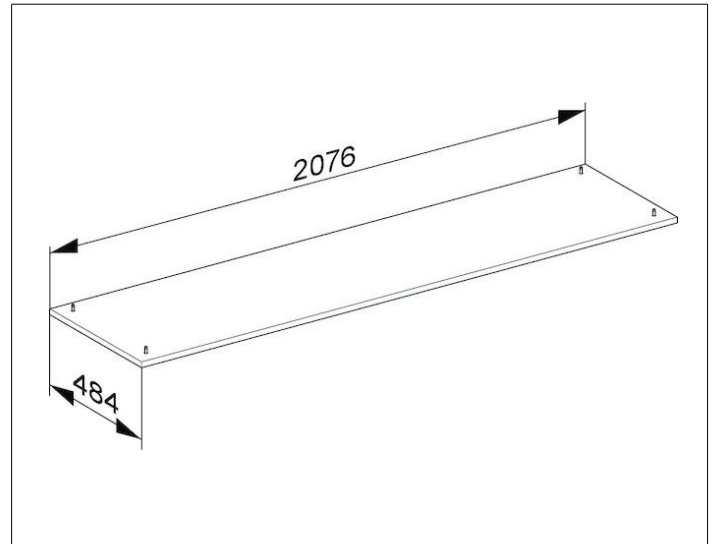

**OBERFLÄCHE**

Eiche cashmere/Eiche cashmere

**ABMESSUNG**

2076 x 25 x 484 mm