

X-Line  
3329818200 Lichtspiegel

**PRODUKT**

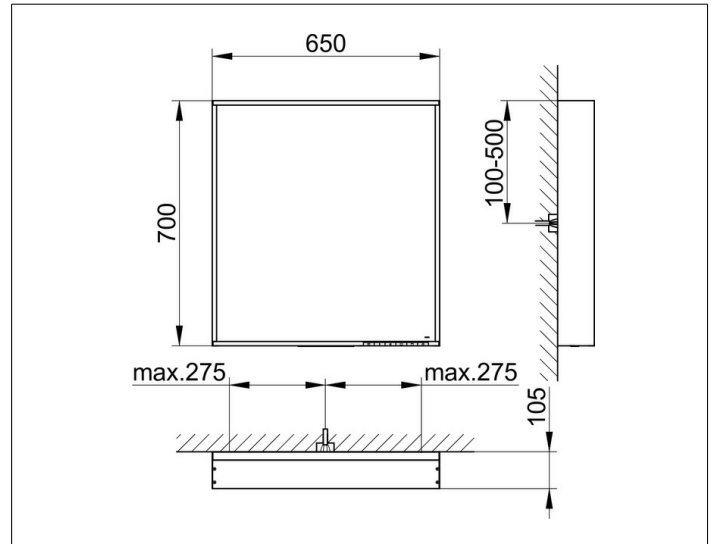

**ZEICHNUNG**



EEK: C , 30 kWh/1000h

**OBERFLÄCHE**

cashmere

**ABMESSUNG**

650 x 700 x 105 mm