

Edition 11

3126830000 Waschtischunterbau

PRODUKT



ZEICHNUNG

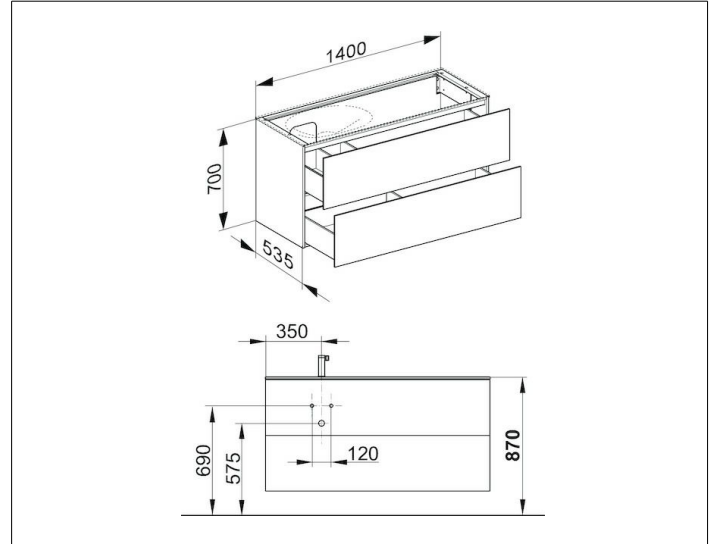

OBERFLÄCHE

weiß/Glas weiß

ABMESSUNG

1400 x 700 x 535 mm