

Edition 11

31253280000 Waschtischunterbau

**PRODUKT**

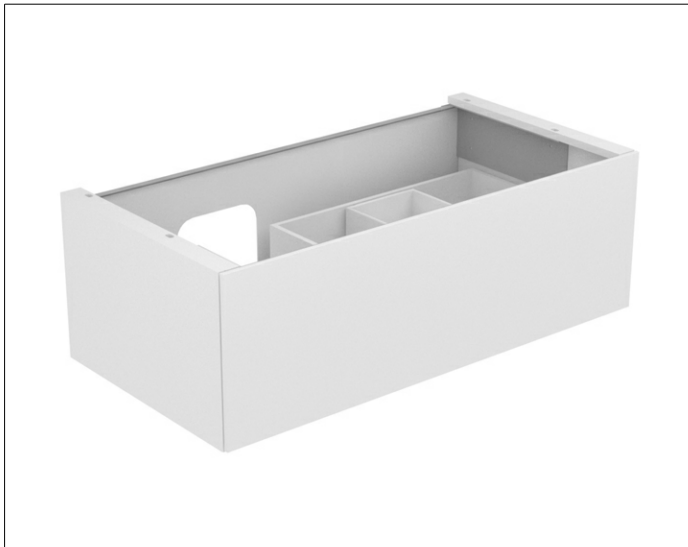

**ZEICHNUNG**

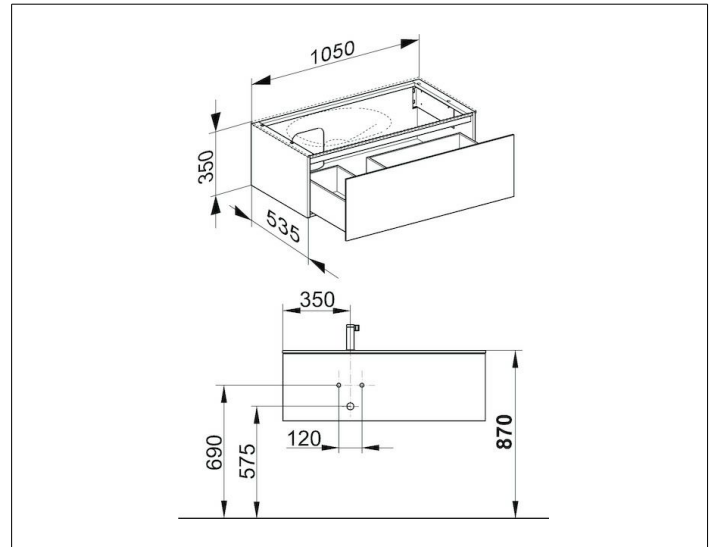

**OBERFLÄCHE**

cashmere/Glas cashmere satiniert

**ABMESSUNG**

1050 x 350 x 535 mm