

Edition 11

31312110000 Modul Unterbauschrank

PRODUKT



ZEICHNUNG

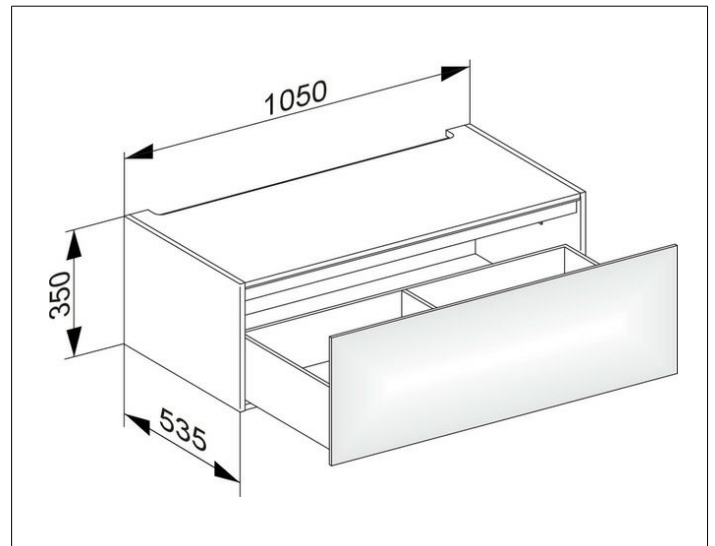

OBERFLÄCHE

anthrazit/Glas anthrazit

ABMESSUNG

1050 x 350 x 535 mm