

Edition 11

31324289001 Abdeckplatte

PRODUKT

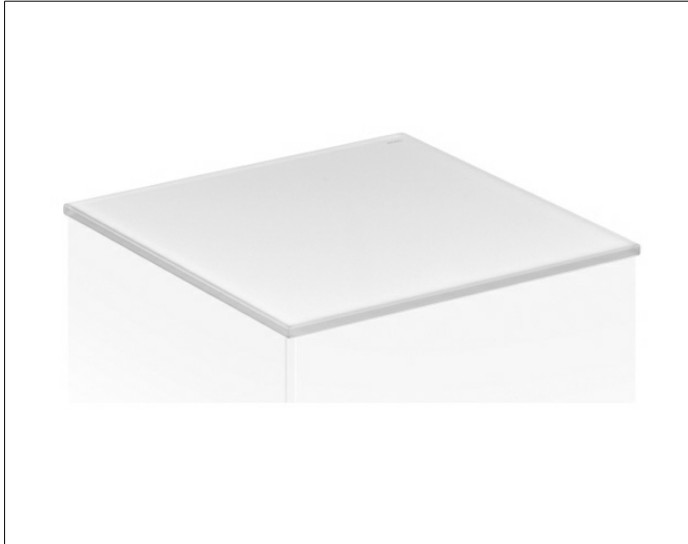

ZEICHNUNG

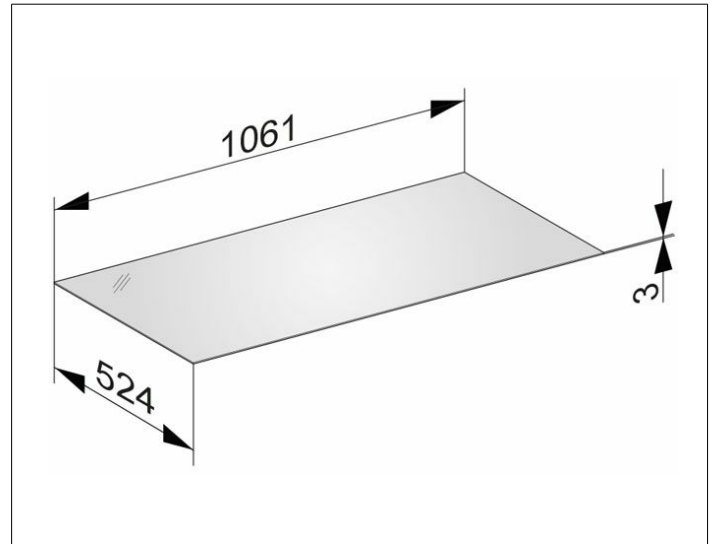

OBERFLÄCHE

cashmere/Glas cashmere satiniert

ABMESSUNG

1061 x 3 x 524 mm