

Edition 400

31720150002 Mittelschrank

PRODUKT



ZEICHNUNG

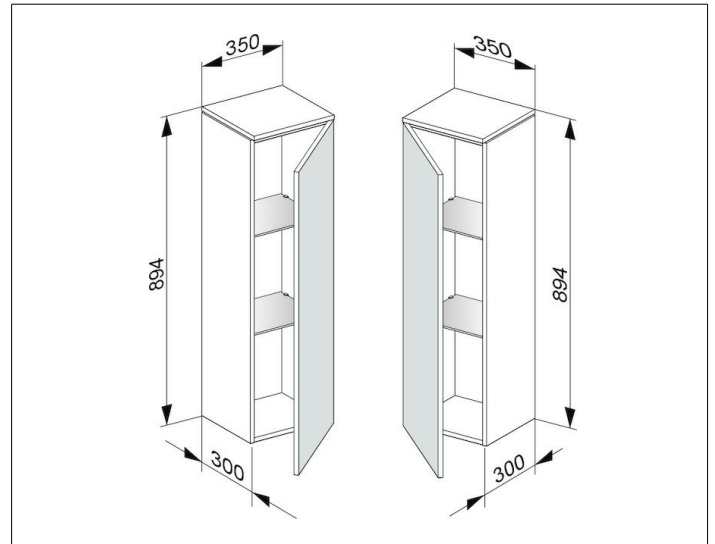

OBERFLÄCHE

anthrazit/Glas anthrazit satiniert

ABMESSUNG

350 x 894 x 300 mm