

X-Line
3329818100 Lichtspiegel

PRODUKT

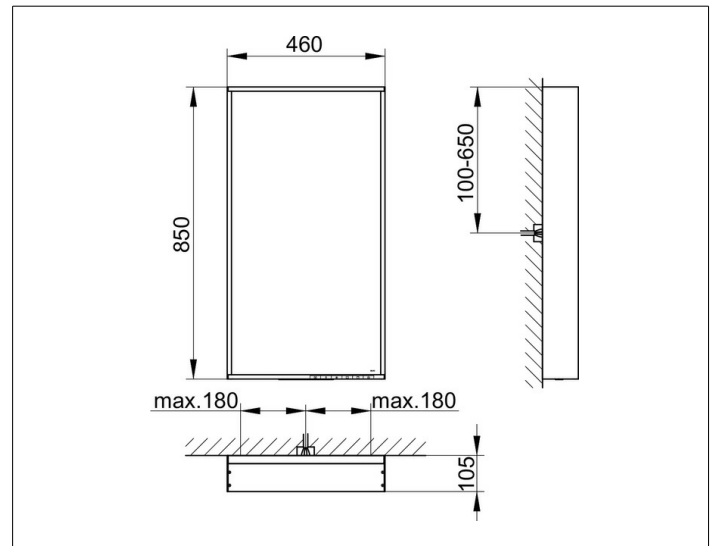

ZEICHNUNG



EEK: C , 25 kWh/1000h

OBERFLÄCHE

cashmere

ABMESSUNG

460 x 850 x 105 mm