

Edition 400

31749390000 Sockelpaket

PRODUKT

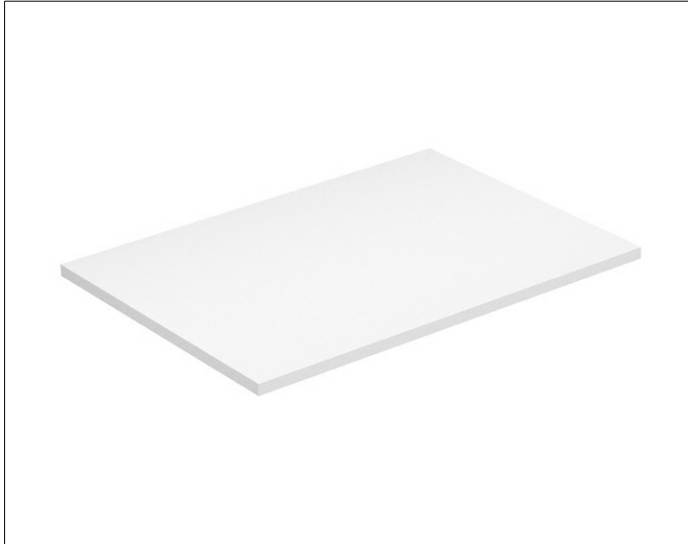

ZEICHNUNG

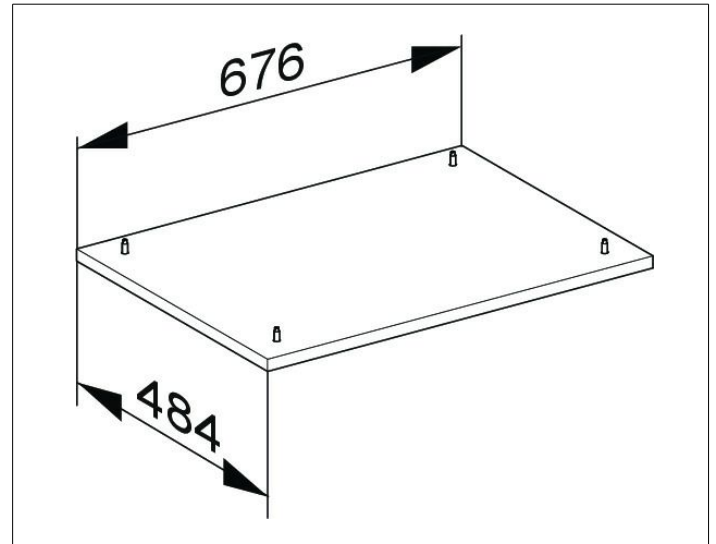

OBERFLÄCHE

anthrazit/anthrazit

ABMESSUNG

676 x 25 x 484 mm