

Edition 400

31571860000 Waschtischunterbau

PRODUKT



ZEICHNUNG

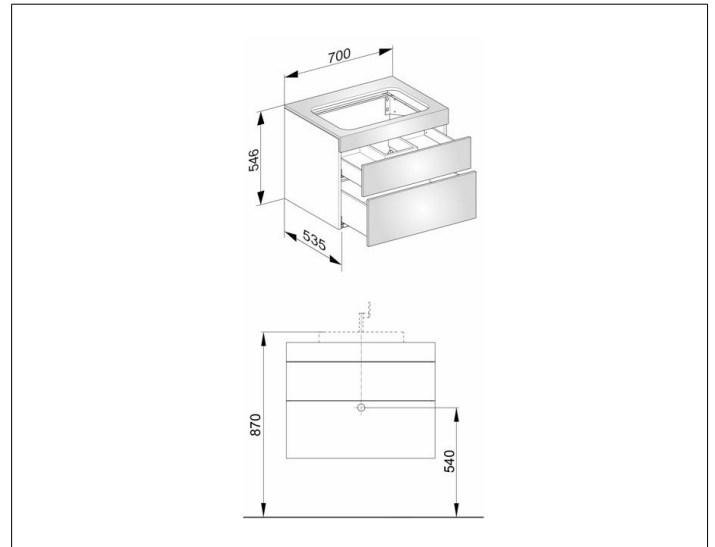

OBERFLÄCHE

Eiche anthrazit/Eiche anthrazit

ABMESSUNG

700 x 546 x 535 mm