

Edition 11

3131430000 Modul Unterbauschrank

PRODUKT

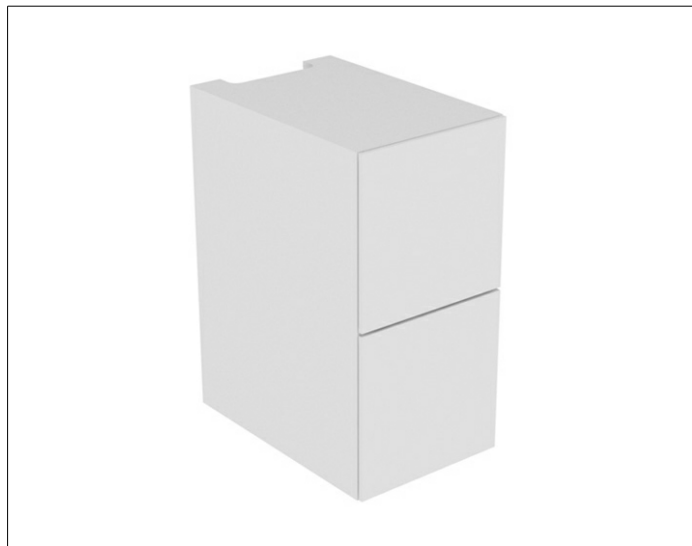

ZEICHNUNG

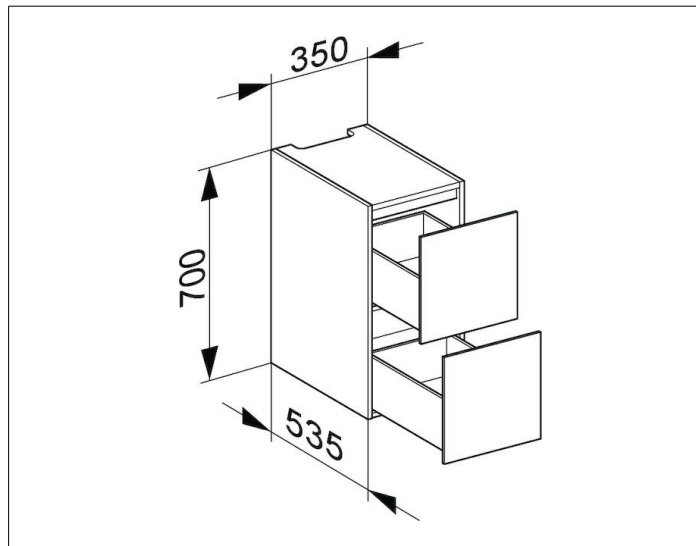

OBERFLÄCHE

weiß/Glas weiß

ABMESSUNG

350 x 700 x 535 mm