

X-Line

33151290000 Waschtischunterbau

PRODUKT

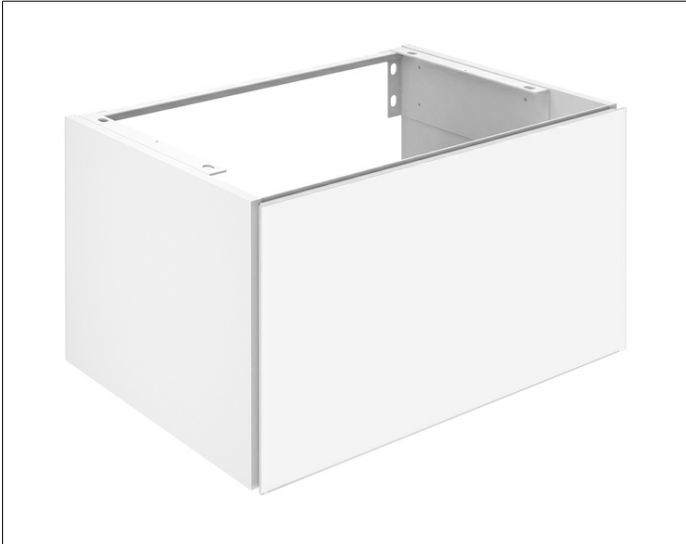

ZEICHNUNG

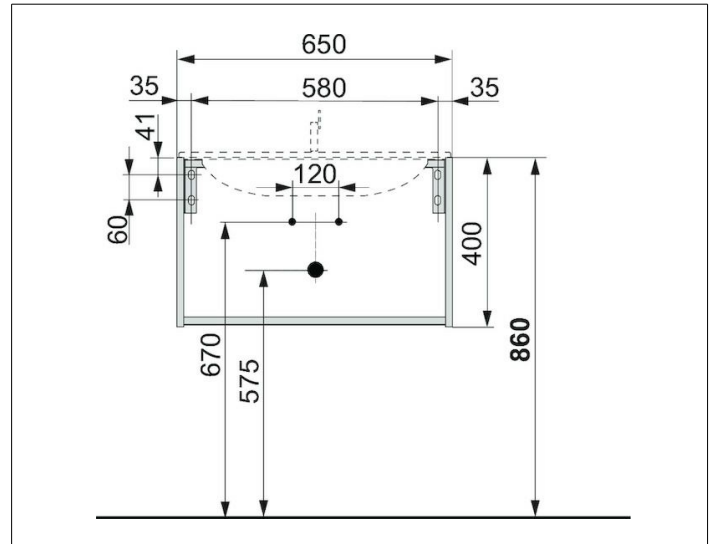

OBERFLÄCHE

inox/inox

ABMESSUNG

650 x 400 x 490 mm