

Edition 11

31311390100 Modul Unterbauschrank

**PRODUKT**

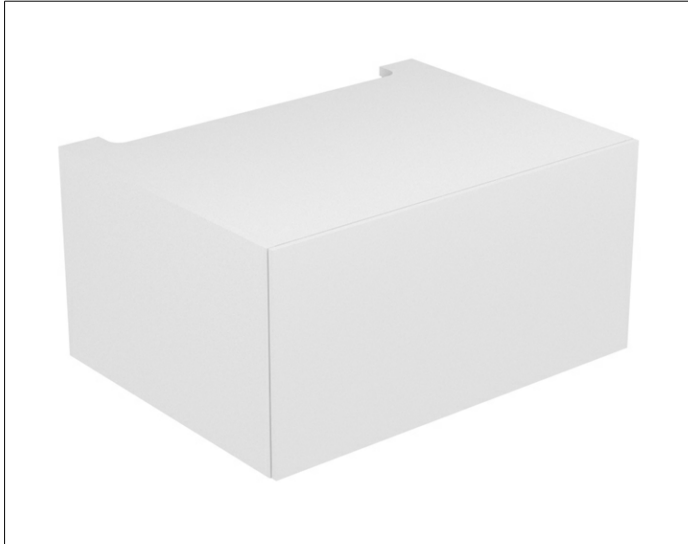

**ZEICHNUNG**

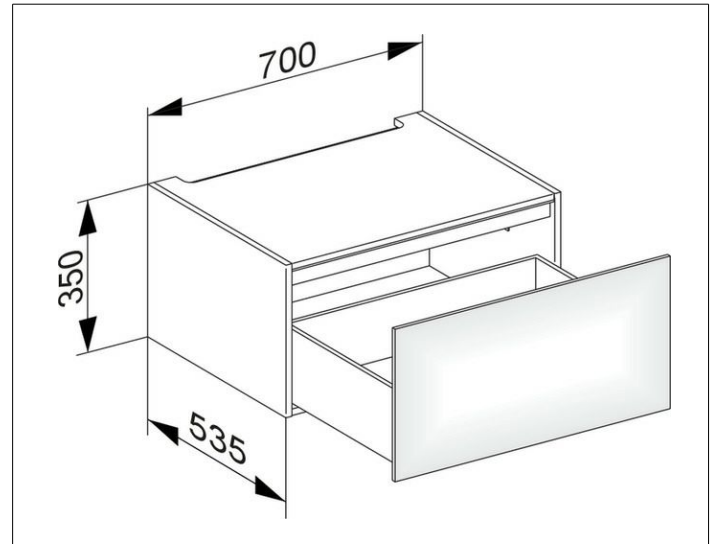

EEK: F , 5 kWh/1000h

**OBERFLÄCHE**

anthrazit/anthrazit

**ABMESSUNG**

700 x 350 x 535 mm