

Edition 11

31361890100 Waschtischunterbau

PRODUKT

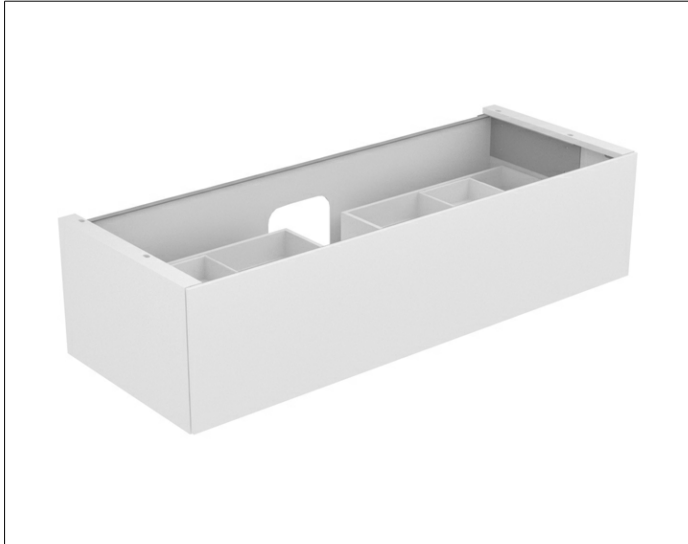

ZEICHNUNG

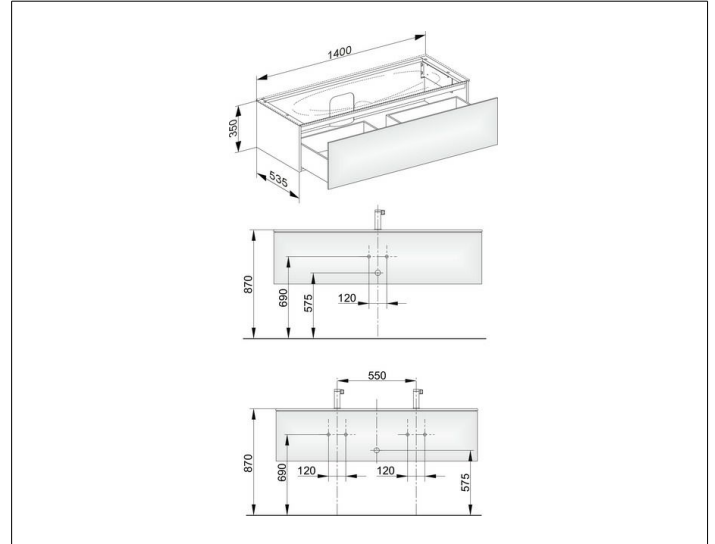

EEK: F , 10 kWh/1000h

OBERFLÄCHE

Eiche-hell Furnier/Eiche-hell Furnier

ABMESSUNG

1400 x 350 x 535 mm