

Edition 11

31341380100 Waschtischunterbau

PRODUKT

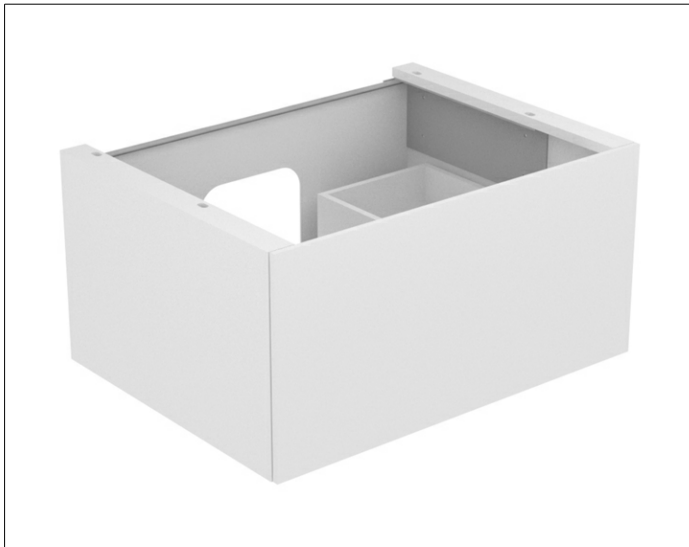

ZEICHNUNG

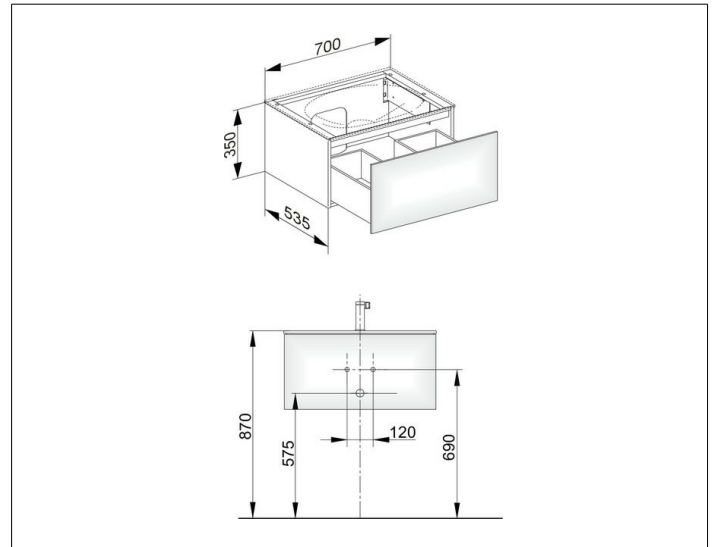

EEK: F , 5 kWh/1000h

OBERFLÄCHE

weiß/weiß

ABMESSUNG

700 x 350 x 535 mm