

Edition 400

31759870000 Sockelpaket

PRODUKT



ZEICHNUNG

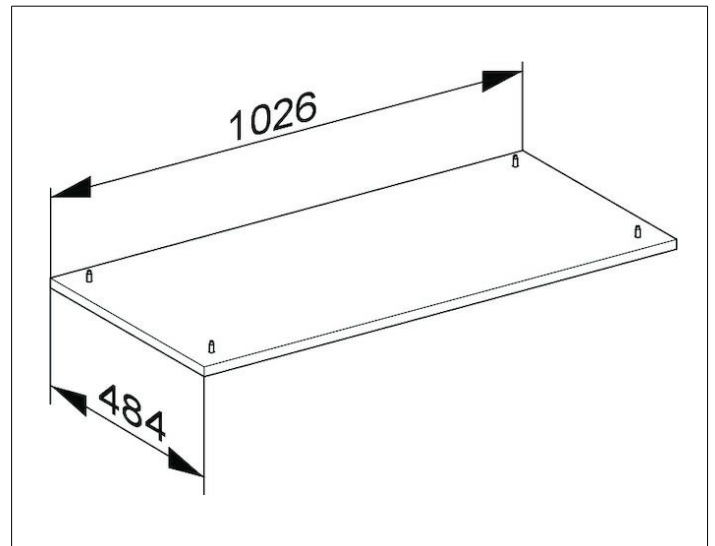

OBERFLÄCHE

Eiche cashmere/Eiche cashmere

ABMESSUNG

1026 x 25 x 484 mm