

Edition 400

31571680000 Waschtischunterbau

PRODUKT



ZEICHNUNG

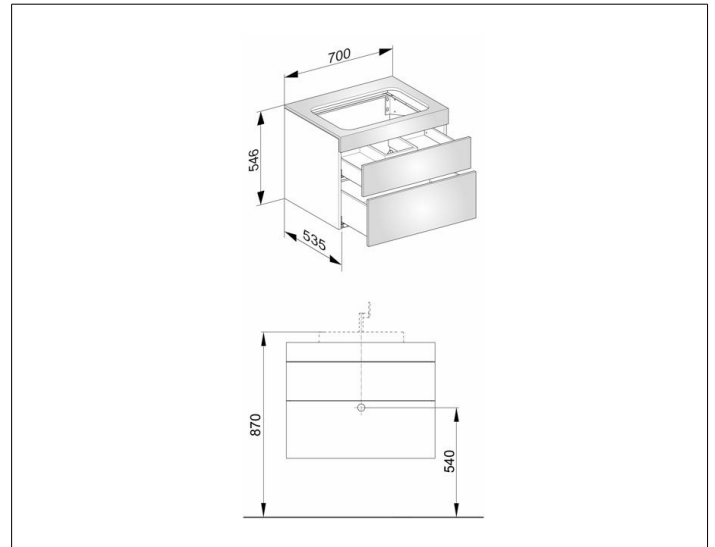

OBERFLÄCHE

Nussbaum/Nussbaum

ABMESSUNG

700 x 546 x 535 mm