

Edition 11

31241300100 Waschtischunterbau

PRODUKT

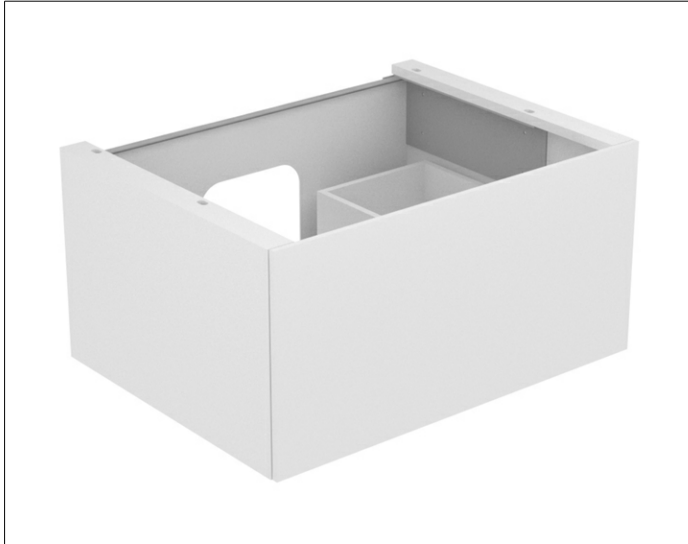

ZEICHNUNG

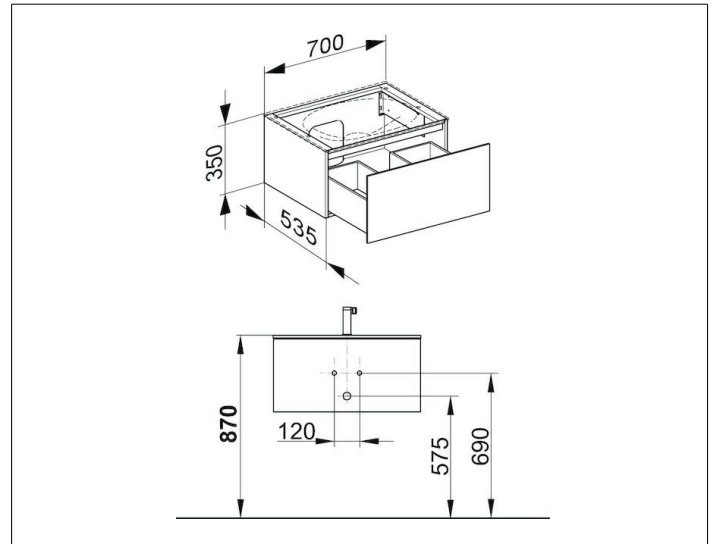

EEK: F , 5 kWh/1000h

OBERFLÄCHE

weiß/Glas weiß

ABMESSUNG

700 x 350 x 535 mm