

Edition 11

31310380100 Modul Unterbauschrank

PRODUKT

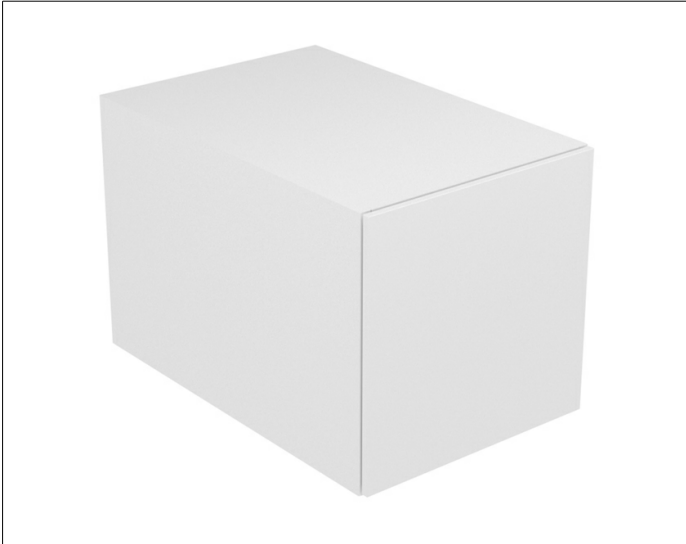

ZEICHNUNG

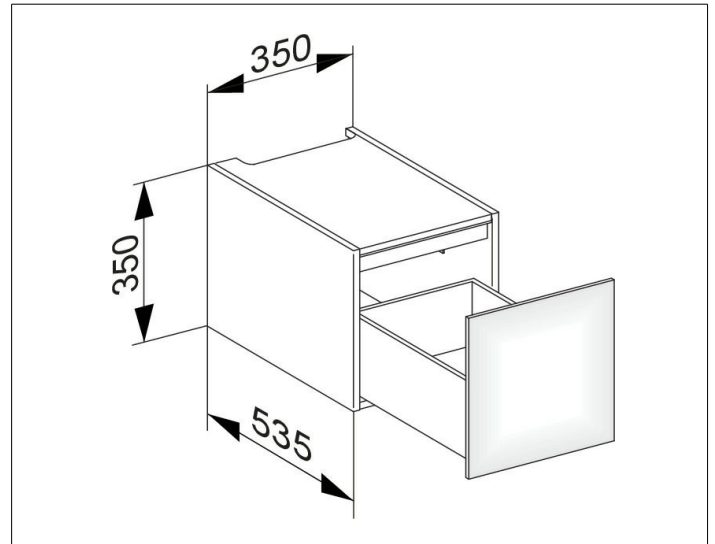

EEK: F , 2 kWh/1000h

OBERFLÄCHE

weiß/weiß

ABMESSUNG

350 x 350 x 535 mm