

Edition 11

31166380100 Waschtischunterbau

**PRODUKT**

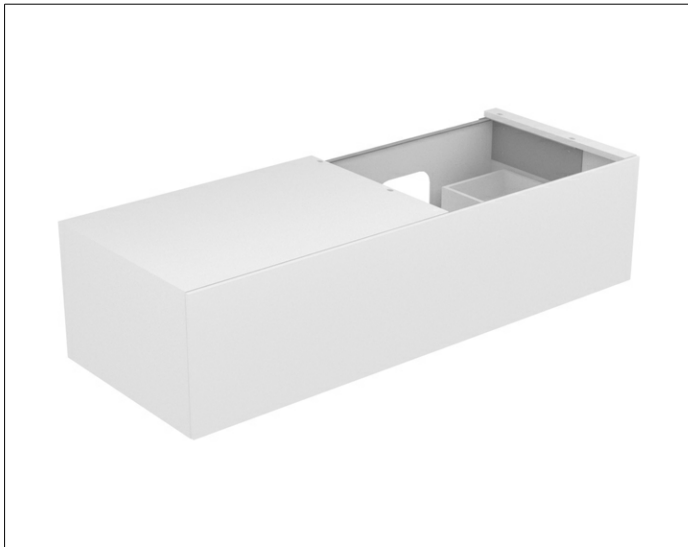

**ZEICHNUNG**

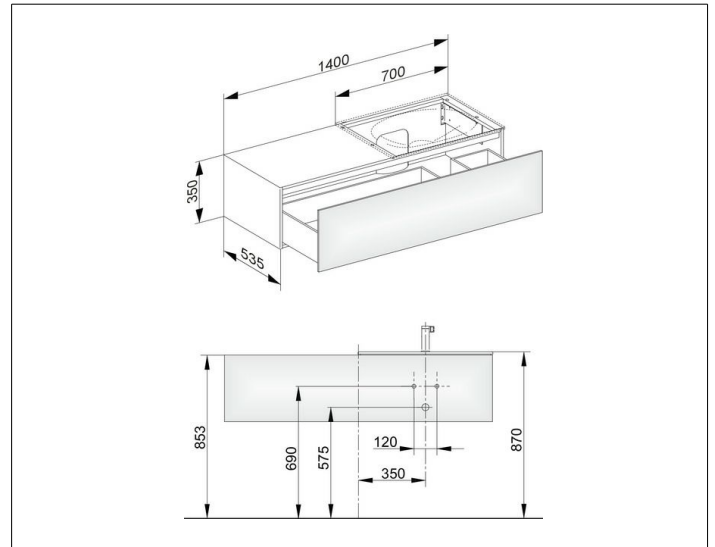

EEK: F , 10 kWh/1000h

**OBERFLÄCHE**

weiß/weiß

**ABMESSUNG**

1400 x 350 x 535 mm