

Edition 11

31264380100 Waschtischunterbau

PRODUKT

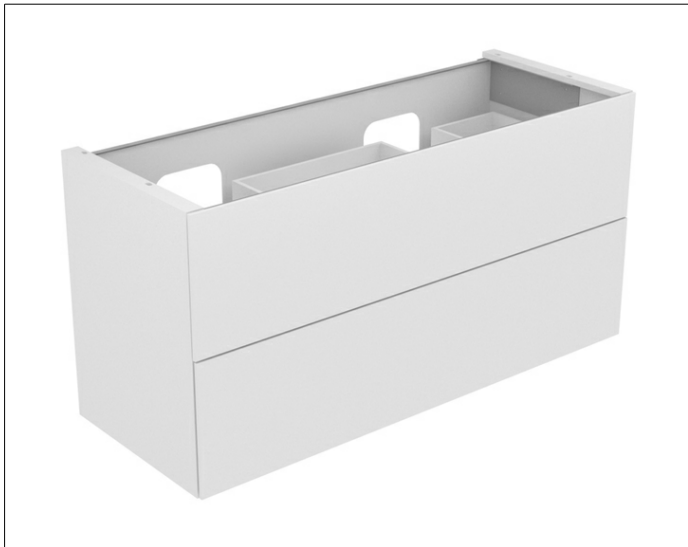

ZEICHNUNG

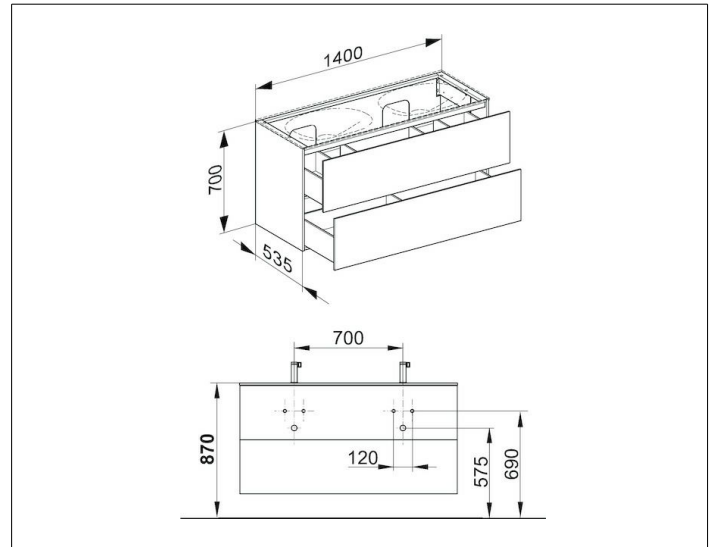

EEK: F , 10 kWh/1000h

OBERFLÄCHE

weiß/weiß

ABMESSUNG

1400 x 700 x 535 mm