

Edition 400

31720740002 Mittelschrank

PRODUKT



ZEICHNUNG

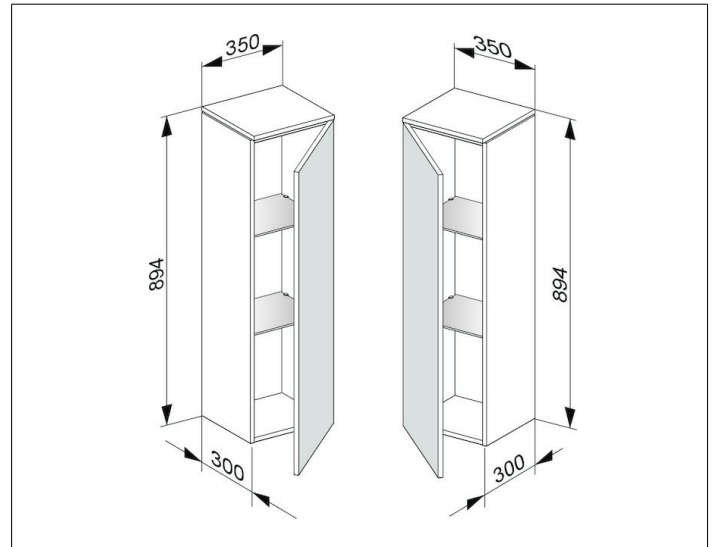

OBERFLÄCHE

weiß/Glas cashmere klar

ABMESSUNG

350 x 894 x 300 mm