

Edition 11

31313370100 Modul Unterbauschrank

PRODUKT



ZEICHNUNG

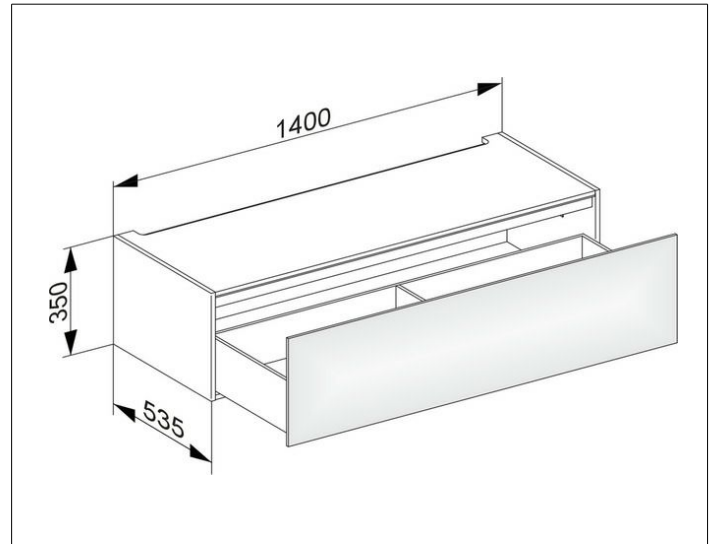

EEK: F , 10 kWh/1000h

OBERFLÄCHE

trüffel/trüffel

ABMESSUNG

1400 x 350 x 535 mm