

Edition 11

31310570100 Modul Unterbauschrank

PRODUKT

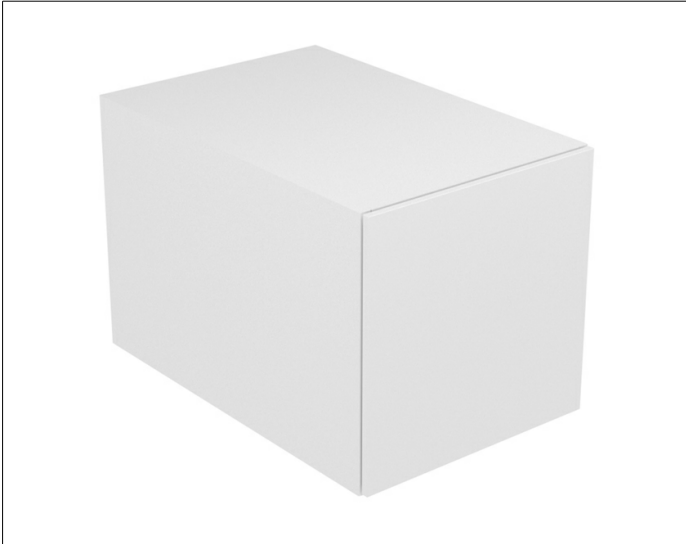

ZEICHNUNG

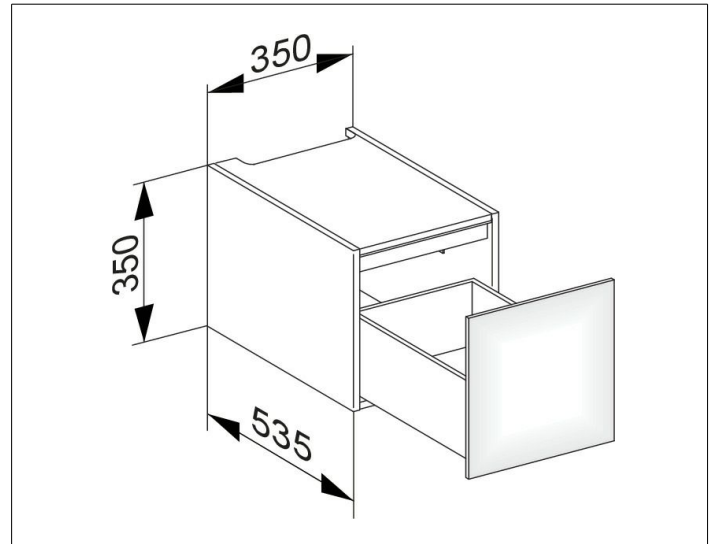

EEK: F , 2 kWh/1000h

OBERFLÄCHE

schwarz/Glas schwarz

ABMESSUNG

350 x 350 x 535 mm