

Edition 400

3157570000 Waschtischunterbau

PRODUKT



ZEICHNUNG

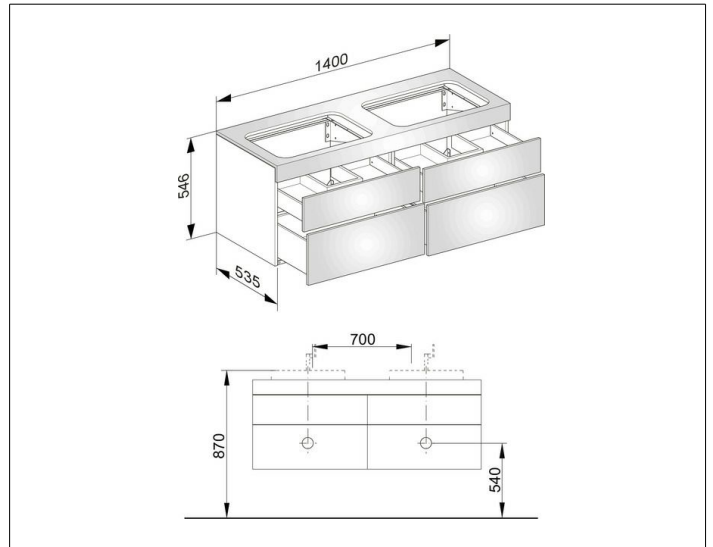

OBERFLÄCHE

weiß/Glas anthrazit klar

ABMESSUNG

1400 x 546 x 535 mm