

X-Line

3317229000 Waschtischunterbau

PRODUKT

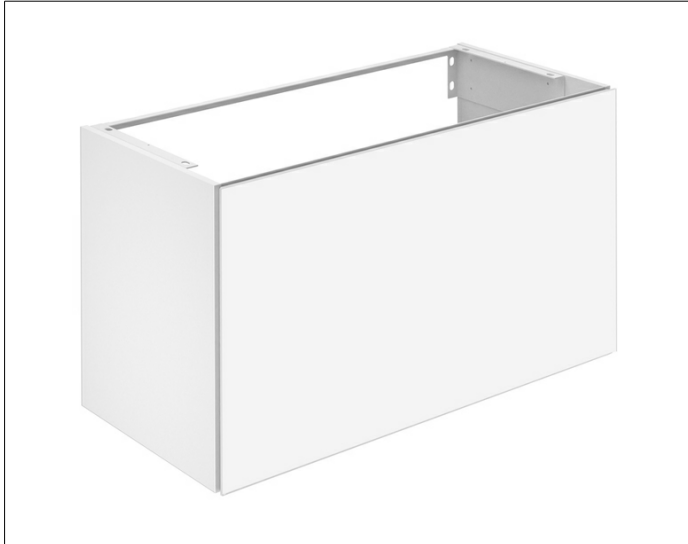

ZEICHNUNG

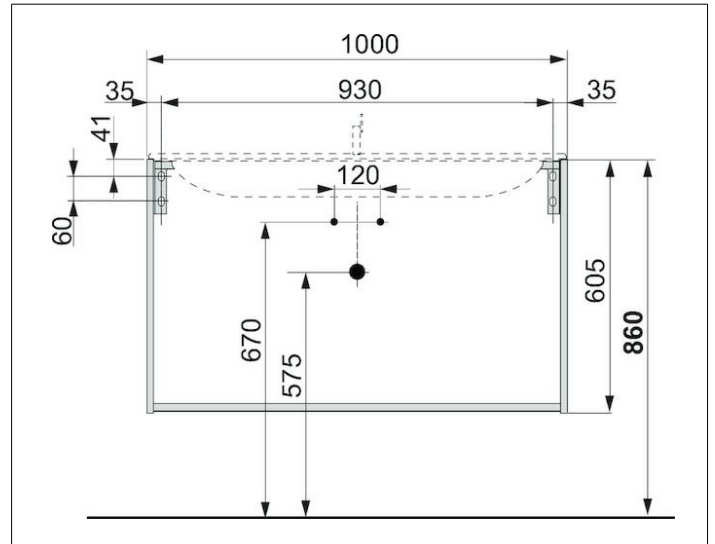

OBERFLÄCHE

inox/inox

ABMESSUNG

1000 x 605 x 490 mm