

Edition 11

31322189001 Abdeckplatte

**PRODUKT**

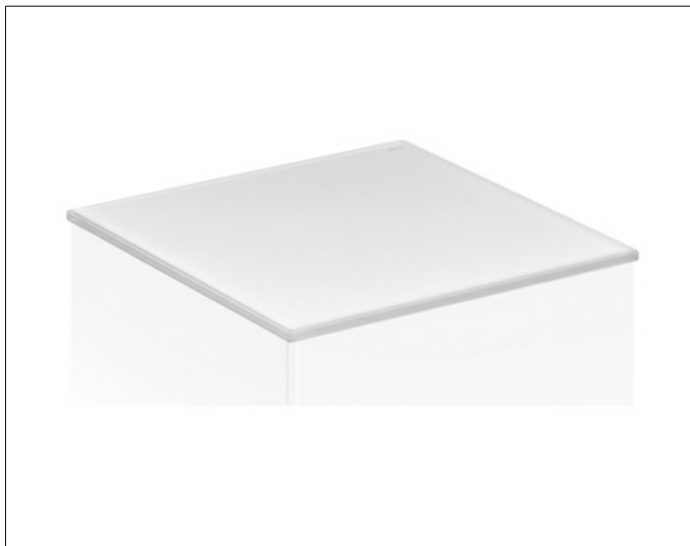

**ZEICHNUNG**

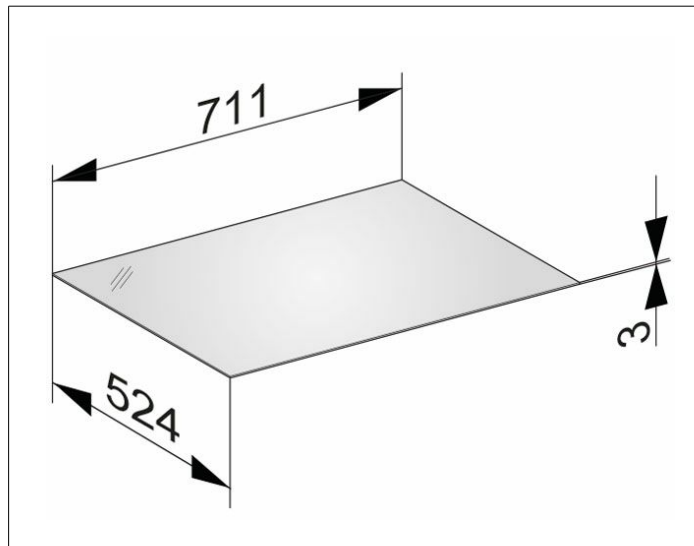

**OBERFLÄCHE**

cashmere/Glas cashmere

**ABMESSUNG**

711 x 3 x 524 mm