

Edition 400

31720280002 Mittelschrank

**PRODUKT**



**ZEICHNUNG**

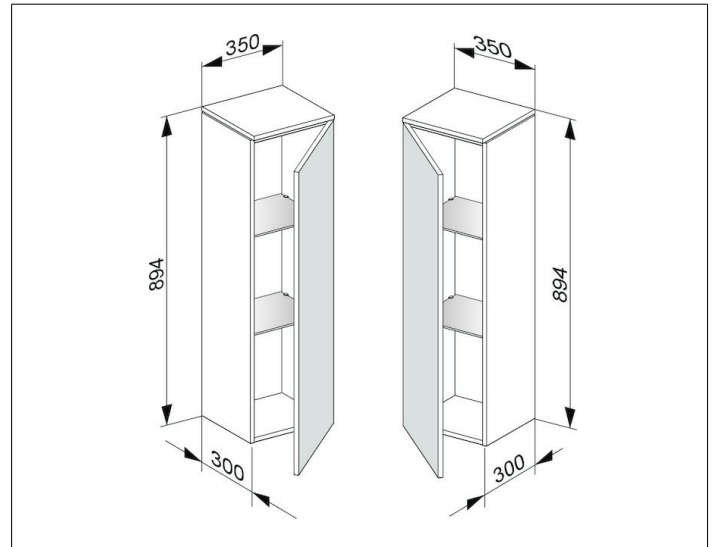

**OBERFLÄCHE**

cashmere/Glas cashmere satiniert

**ABMESSUNG**

350 x 894 x 300 mm