

Edition 11

31165330100 Waschtischunterbau

PRODUKT

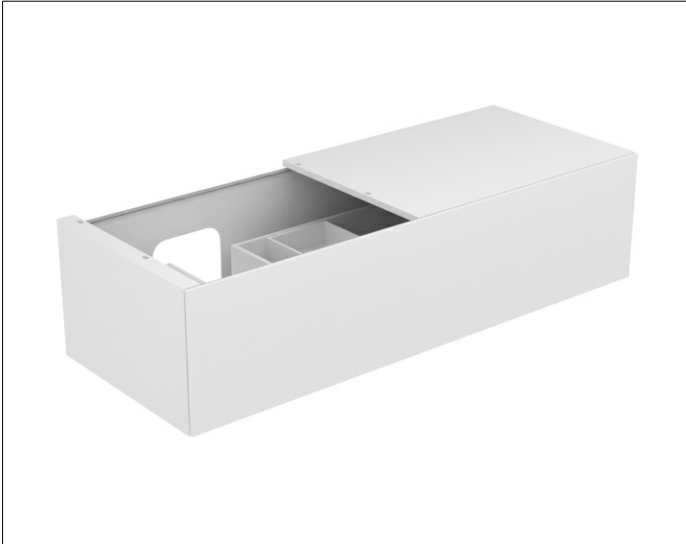

ZEICHNUNG

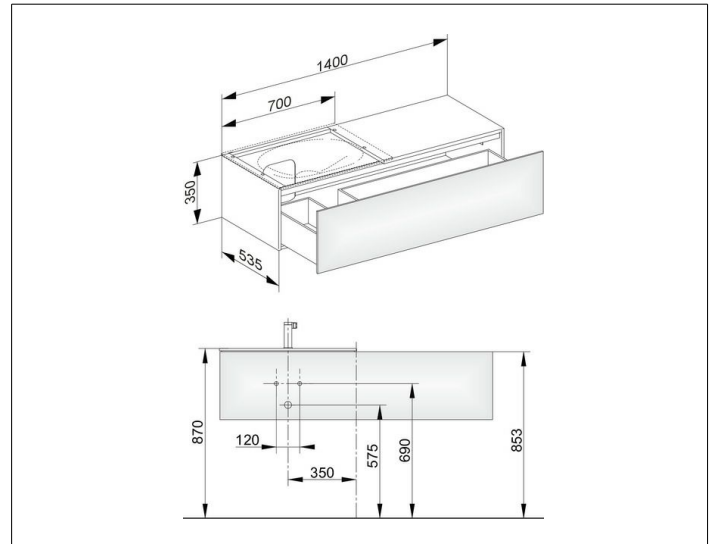

EEK: F ,

OBERFLÄCHE

schwarz gebürstet

ABMESSUNG

1400 x 350 x 535 mm