

Edition 11

3131130000 Modul Unterbauschrank

**PRODUKT**

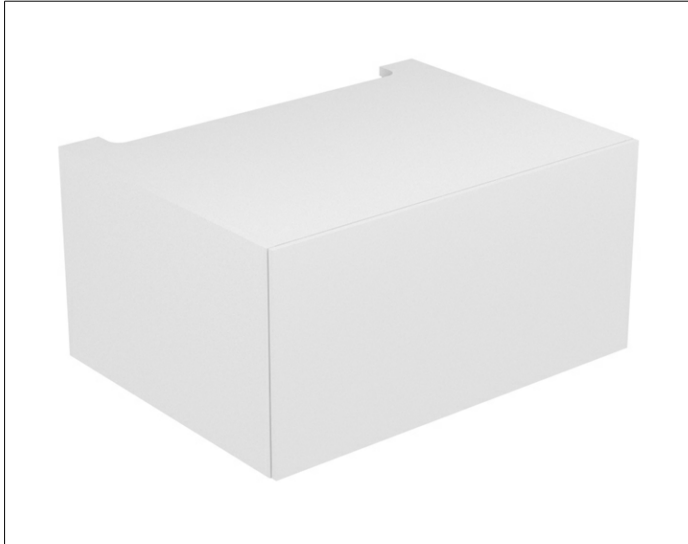

**ZEICHNUNG**

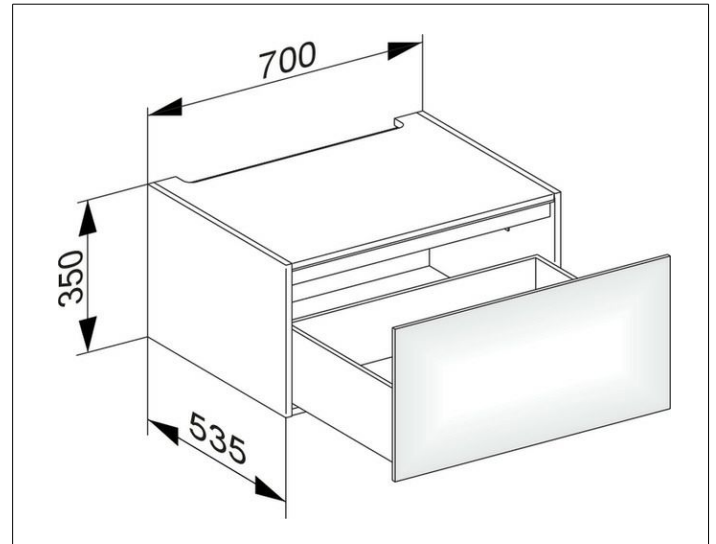

**OBERFLÄCHE**

weiß/Glas weiß

**ABMESSUNG**

700 x 350 x 535 mm