

Edition 11

31320289000 Abdeckplatte

**PRODUKT**

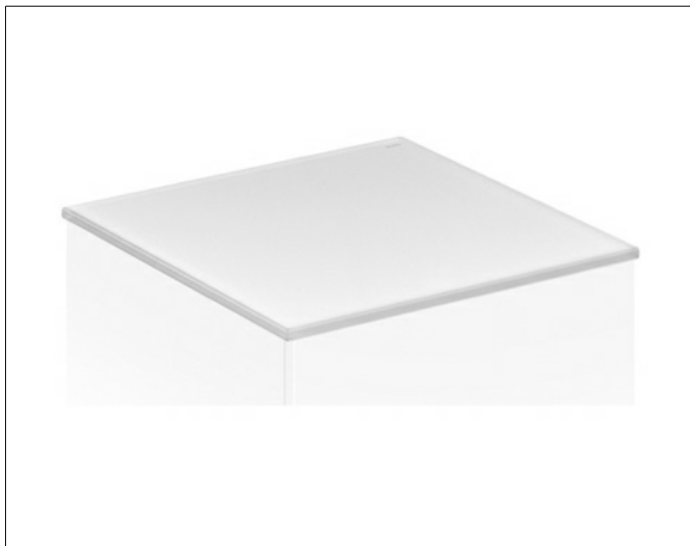

**ZEICHNUNG**

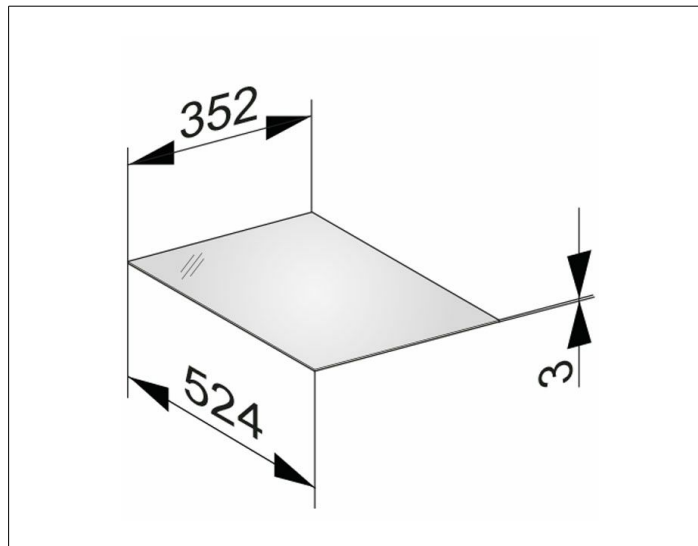

**OBERFLÄCHE**

cashmere/Glas cashmere satiniert

**ABMESSUNG**

352 x 3 x 524 mm