

Edition 11

11164009000 Echkristall-Einsatz

PRODUKT



ZEICHNUNG

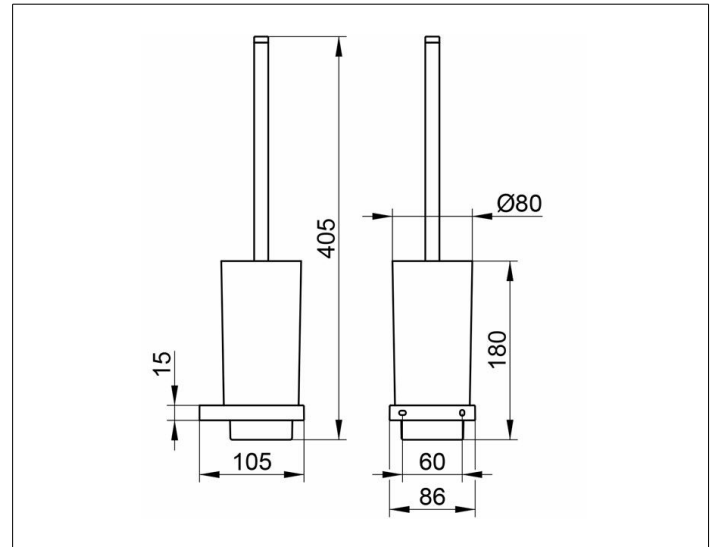

PRODUKTBESCHREIBUNG

mattiert, lose