

Edition 11

31361180000 Waschtischunterbau

**PRODUKT**

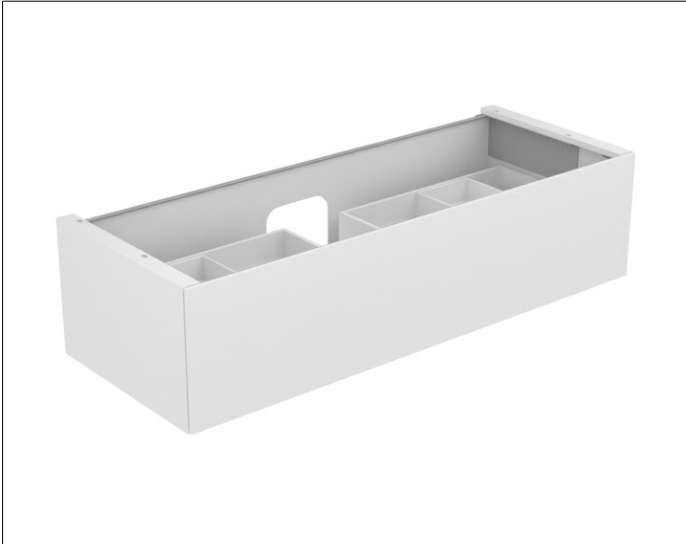

**ZEICHNUNG**

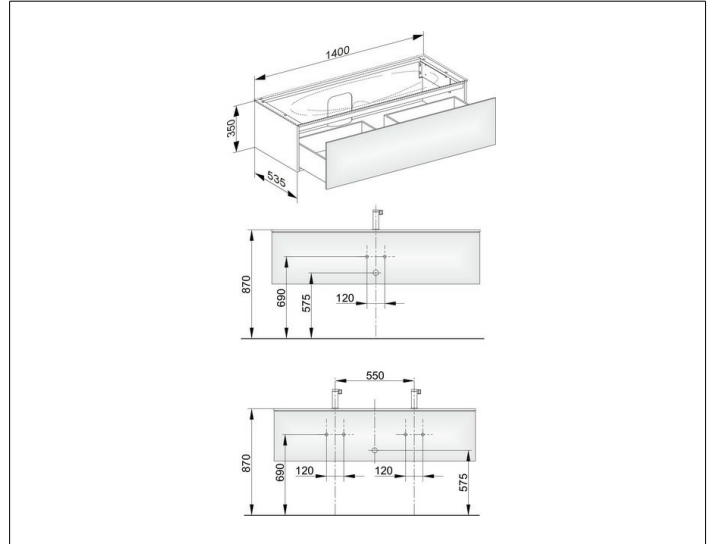

**OBERFLÄCHE**

cashmere/Glas cashmere

**ABMESSUNG**

1400 x 350 x 535 mm