

Edition 11

31241380000 Waschtischunterbau

**PRODUKT**

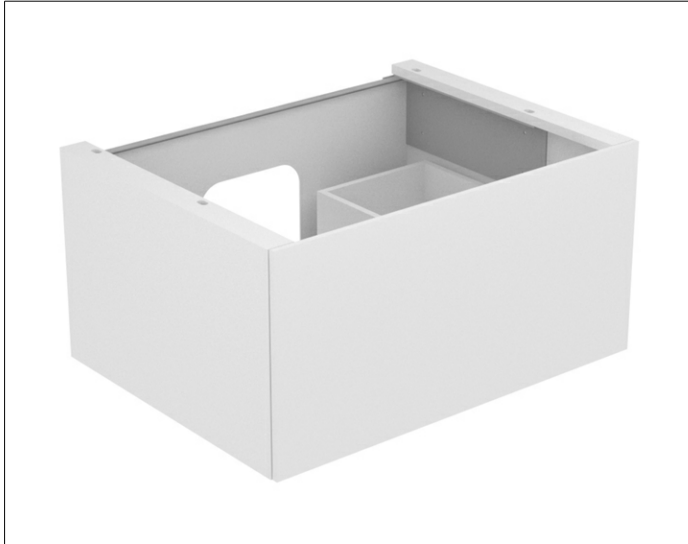

**ZEICHNUNG**

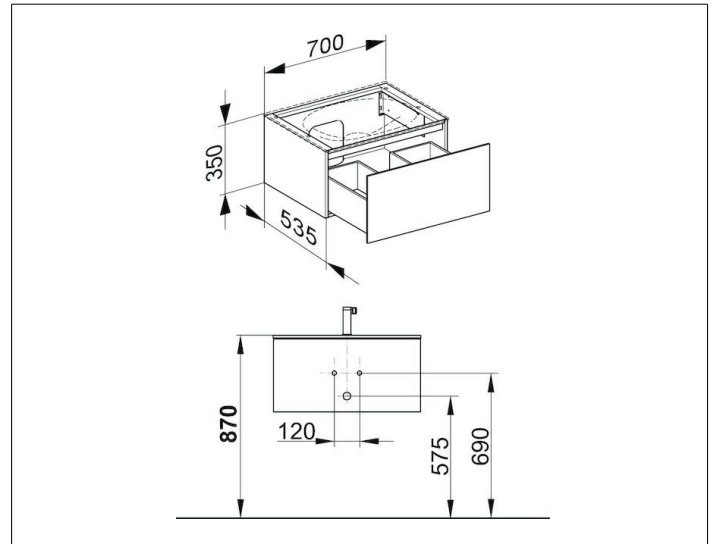

**OBERFLÄCHE**

weiß/weiß

**ABMESSUNG**

700 x 350 x 535 mm