

Edition 11

31312280000 Modul Unterbauschrank

PRODUKT



ZEICHNUNG

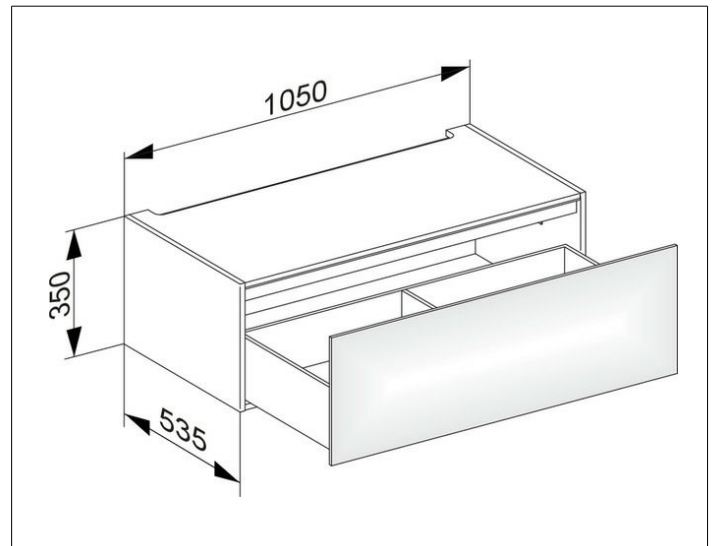

OBERFLÄCHE

cashmere/Glas cashmere satiniert

ABMESSUNG

1050 x 350 x 535 mm