

Edition 11

31313390000 Modul Unterbauschrank

PRODUKT



ZEICHNUNG

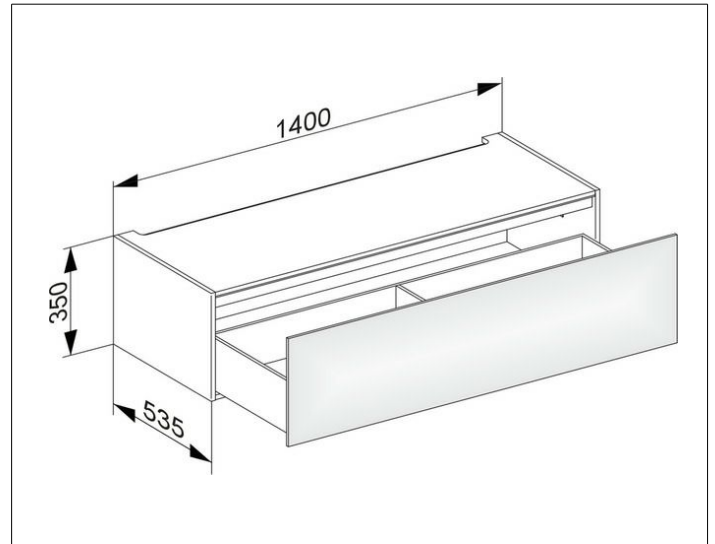

OBERFLÄCHE

anthrazit/anthrazit

ABMESSUNG

1400 x 350 x 535 mm