

Edition 11

31341370100 Waschtischunterbau

PRODUKT

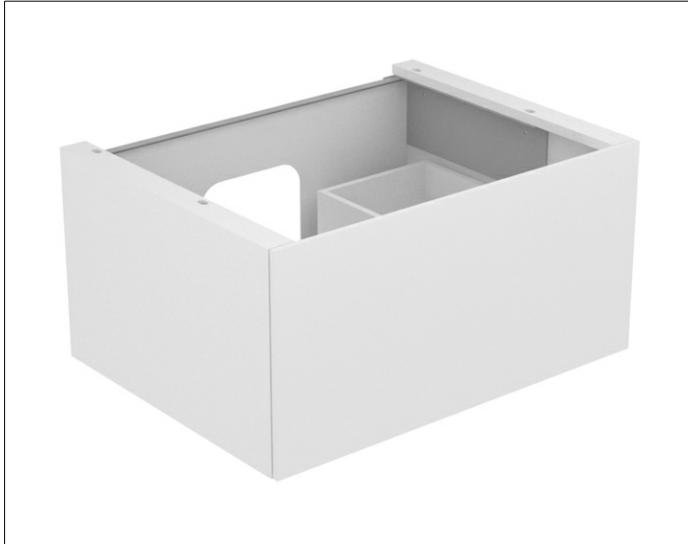

ZEICHNUNG

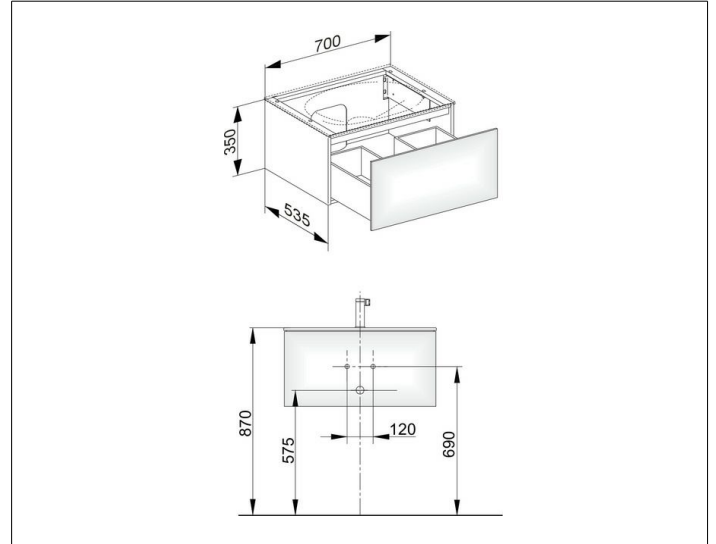

EEK: F , 5 kWh/1000h

OBERFLÄCHE

trüffel/trüffel

ABMESSUNG

700 x 350 x 535 mm