

Edition 400

31575860100 Waschtischunterbau

PRODUKT



ZEICHNUNG

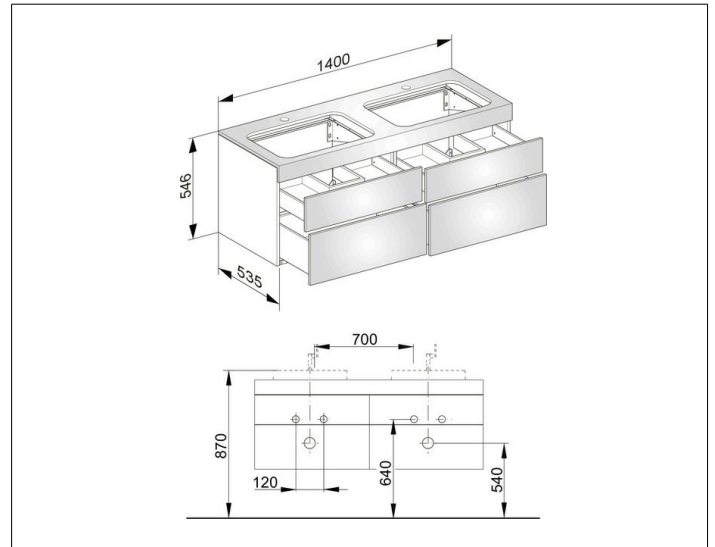

OBERFLÄCHE

Eiche anthrazit/Eiche anthrazit

ABMESSUNG

1400 x 546 x 535 mm